

Concepts

Products

Service



Cleanliness down to the smallest detail.

Lindner Clean Rooms and Laboratories



Lindner

Building New Solutions

Building new solutions.

Lindner undertakes major worldwide projects in all areas of interior finishes, insulation technology, industrial services and building facades. From pre-planning through to project completion Lindner is your partner of choice.

The Company's extensive manufacturing capability enables quality to be strictly maintained whilst allowing maximum flexibility to meet individual project requirements.

Environmental considerations are fundamental to all Lindner's business principles.

Through partnerships with clients Lindner turns concepts into reality.

Choosing Lindner you have:

Lindner Concepts:
Tailored solutions specifically geared to satisfy individual project requirements

Lindner Products:
Quality materials and systems to the very highest industry standards

Lindner Service:
Comprehensive project management services

Lindner Clean Rooms

From design to implementation.

On request we will undertake total implementation of all areas of your project. Working with yourselves and with the wide-ranging planning expertise of our specialists we will find an economical clean room solution. We will also take responsibility for all areas from analysis and consultation through to planning, manufacturing, training and maintenance.



Campeon, Neubiberg

Advantages at a glance

- Over 40 years of experience in the development of clean room concepts
- All services from one source
- We offer you flexible solutions for all your requirements

Contents

| | |
|----------------------------------|---------|
| Lindner Clean Room Ceilings | 5 - 16 |
| Lindner Clean Room Walls | 17 - 30 |
| Lindner Clean Room Doors | 31 - 34 |
| Lindner Clean Room Raised Floors | 35 - 44 |
| Lindner Clean Room Lights | 45 - 54 |
| Lindner Clean Air Technology | 55 - 57 |
| Locks | 58 - 59 |
| Surfaces | 60 |
| Guide specifications | 61 |
| Standards and regulations | 62 - 63 |



GMP-Apotheke, Düsseldorf



Armed Forces Hospital, Berlin

Lindner Clean Room Ceilings

Ideal conditions.

Ideal requirements for the most modern production: Lindner manufactures your individual ceiling system to your specific needs and the required clean room classification. All clean room related standards and legislation are taken into account. You also have the choice of different types of ceiling panels, modules, materials and surfaces.



Geframed, Bonn

Areas of application

- Pharmacy and medical technology
- Electronic and semiconductor technology
- Microsystems & precision mechanics engineering and optics.
- OP technology
- Laboratories
- Food technology
- Computer rooms and control centres
- Surface treatment technology

Line 55A

The aluminium grid system Line 55A is ideal for use in sterile areas where flush mountings, a minimum number of joints and a high degree of surface stress resistance are the most important features of a ceiling. A technologically innovative connection between main and post cap cross noggins and pre-formed ends make this system ideal.

Stress resistance levels of up to 150 kg/m² speak for themselves. The dimensions of the suspension components are dependent on the load-bearing weight and on-site building structure.



Technical specifications

| | Line 55A non walkable | Line 55A walkable |
|---|----------------------------------|------------------------------|
| Standard grid dimension ¹⁾ | 1,200 x 1,200 mm | 1,200 x 1,200 mm |
| Maximum suspension distance ²⁾ | 3,600 x 1,200mm | 1,200 x 1,200mm |
| Maximum suspension height | As required | As required |
| System weight ³⁾ | up to 20 kg/m ² | up to 50 kg/m ² |
| System height | 80 mm | 80 mm |
| Grid width | 55 mm | 55 mm |
| Maximum distributed load | - | 150 kg/m ² |
| Maximum point load | - | 150 kg |
| Fire protection class | F0 | F0 |
| Joint width ⁴⁾ | 0.5 mm* or 2.5 mm** | 0.5 mm* or 2.5 mm** |
| Service and maintenance access | From below | From above and below |

1) Special grid dimensions on request

2) Dependent on individual weight and additional load

3) Dependent on system requirements

4) Joints *unsealed and/or **sealed

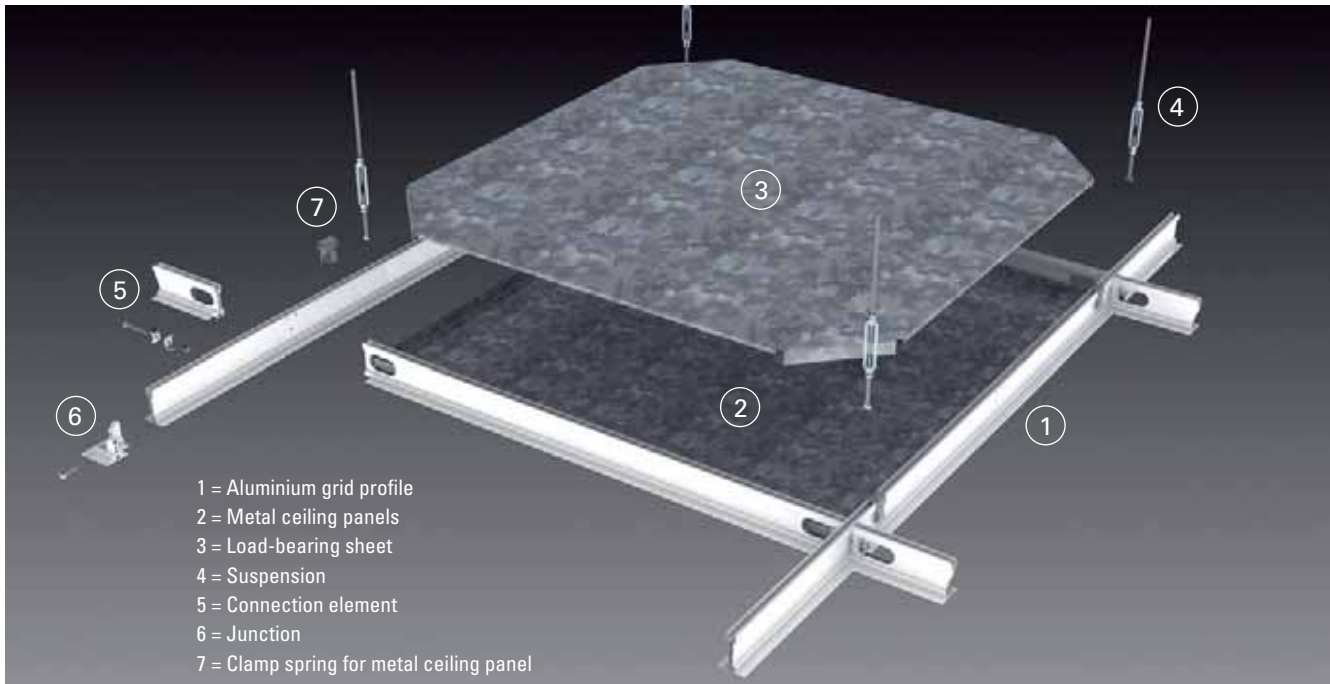

Materials

Grid

Aluminium

Ceiling panels

Steel, stainless steel or aluminium

Accessories

- Clean room suitable inspection hatch
- Clean room suitable smoke and heat extraction hatches (SHE hatches)
- Vibration joint

Options

- Factory assembled cavities for cable and media feed-through
- Mineral wool inlays for improving sound insulation properties
- Factory assembled cut-out for integrated components such as lights, ceiling outlets etc.
- Sliding wall connections in various designs
- Clean room suitable sealants
- Ceiling panels available in either flush or non-flush versions

Special features



- Easy to clean
- Resistant to a variety of cleaning and disinfection agents on the VAH list (The Association for Applied Hygiene)



Ceiling available in walkable versions



Quality standards

Surfaces see page 60

Product characteristics

- Exceptional structural load-bearing capacity
- Fully compatible with ceiling system Crossdata 55A
- Can be installed as a plenum ceiling
- Can be used as a junction ceiling
- Slim-line grid widths
- Various ceiling panel materials and designs available
- Suitable for completely flat FFUs¹⁾

1) FFU Filter Fan Unit

Line 100A

This ceiling system features three separate levels of sealing, pre-formed sections and a high load-bearing capacity, making it a high-end product for use in sterile areas. The aluminium grid system is also impressive in terms of its homogenous load-bearing surface, concealed service feed-throughs and integrated lights which are completely invisible from inside the ceiling cavity – and all tried and tested by the pharmaceutical and medical technology industries. The dimensions of the suspension components are dependent on the load-bearing weight and on-site building structure.

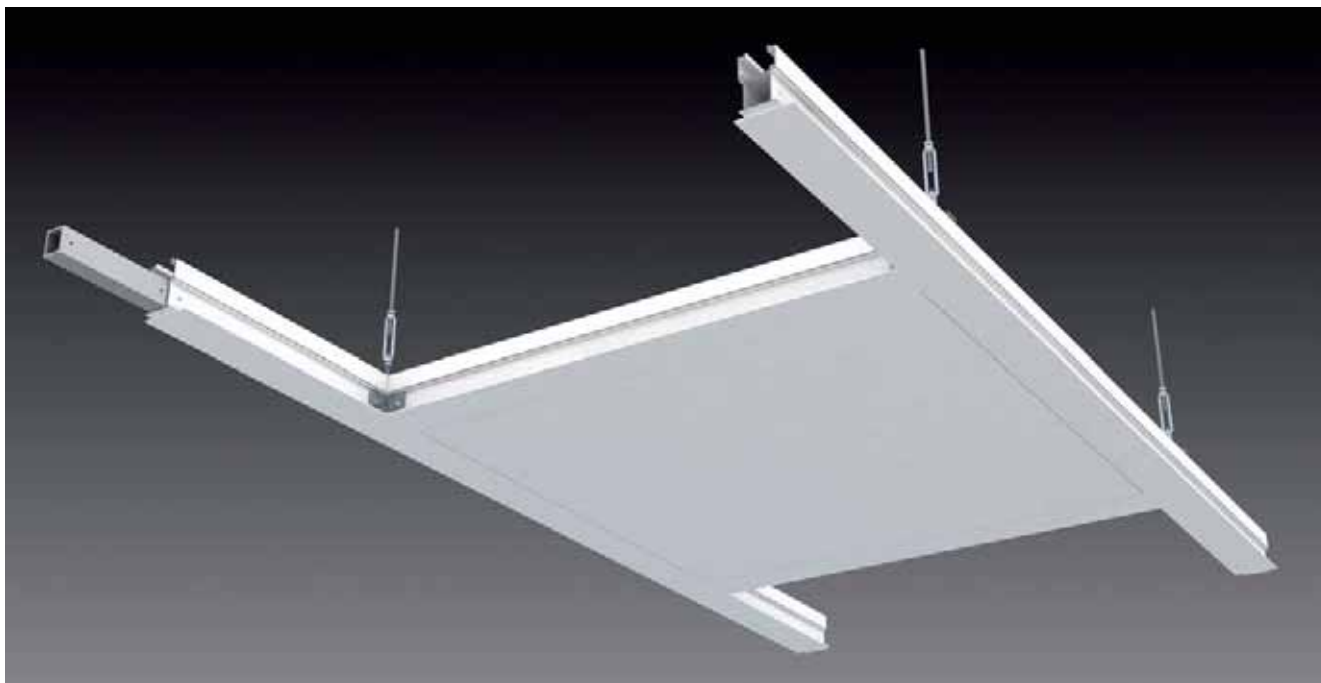

Technical specifications

| | Line 100A non walkable | Line 100A walkable |
|---|-----------------------------------|-------------------------------|
| Standard grid dimension ¹⁾ | 1,200 x 1200 mm | 1,200 x 1200 mm |
| Maximum suspension distance ²⁾ | 3,600 x 1200 mm | 1,200 x 1200 mm |
| Maximum suspension height | As required | As required |
| System weight ³⁾ | up to 20 kg/m ² | up to 50 kg/m ² |
| System height | 100 mm | 100 mm |
| Grid width | 100 mm | 100 mm |
| Maximum distributed load | - | 150 kg/m ² |
| Maximum point load | - | 150 kg |
| Fire protection class | F0 | F0 |
| Joint width ⁴⁾ | 0.5 mm* or 2.5 mm** | 0.5 mm* or 2.5 mm** |
| Service and maintenance access | From below | From above and below |

1) Special grid dimensions on request

2) Dependent on individual weight and additional load

3) Dependent on system requirements

4) Joints *unsealed and/or **sealed

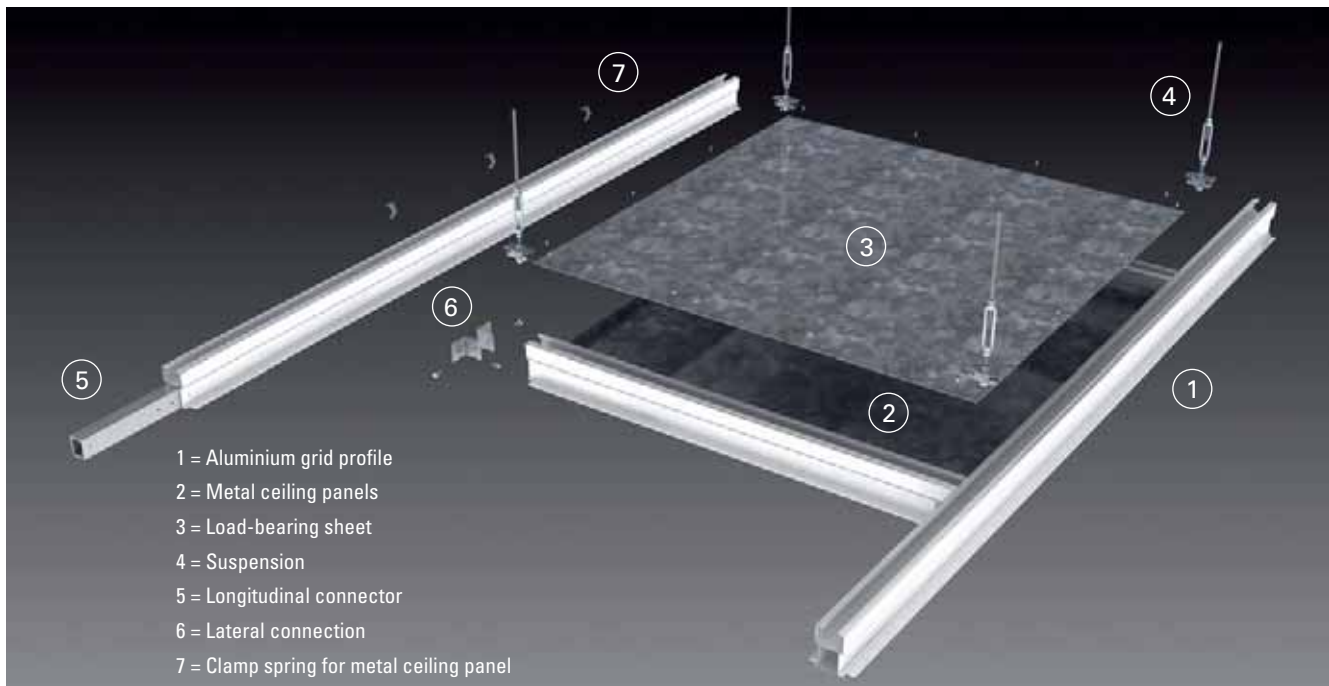

- 1 = Aluminium grid profile
- 2 = Metal ceiling panels
- 3 = Load-bearing sheet
- 4 = Suspension
- 5 = Longitudinal connector
- 6 = Lateral connection
- 7 = Clamp spring for metal ceiling panel

Materials

Grid

Aluminium

Ceiling panels

Steel, stainless steel or aluminium

Accessories

- Grid covering for homogenous load-bearing surfaces
- Clean room suitable inspection hatch
- Clean room suitable smoke and heat extraction hatches (SHE hatches)
- Vibration joint

Options

- Factory assembled cavities for cable and media feed-through
- Mineral wool inlays for improving sound insulation properties
- Factory assembled cut-out for integrated components such as lights, ceiling outlets etc.
- Sliding wall connections in various designs
- Clean room suitable sealants
- Ceiling panels available in either flush or non-flush versions

Special features



- Easy to clean
- Resistant to a variety of cleaning and disinfection agents on the VAH list (The Association for Applied Hygiene)



Ceiling available in walkable versions



Quality standards

Surfaces see page 60

Product characteristics

- Three separate sealing levels
- High structural load-bearing capacity
- Compatible with the Lindner LVT 100 wall system
- Highest density and flexibility levels
- Concealed media feed-throughs
- Clean room lights type LP can be invisibly integrated into the ceiling panel in the grey room
- Various ceiling panel materials and designs available
- Meets high level of aesthetics

Line 100S

The galvanised steel grid ceiling system Line 100S offers a wide range of design options. Whether you require a load-bearing or non load-bearing ceiling, a sandwich ceiling or a corridor ceiling, powder-coated steel or stainless steel – all areas of application can be met. Outsized panel dimensions and a minimum number of suspension points provide the highest level of load-bearing comfort. The dimensions of the suspension components are dependent on the load-bearing weight and on-site building structure.

Line 100S type 2

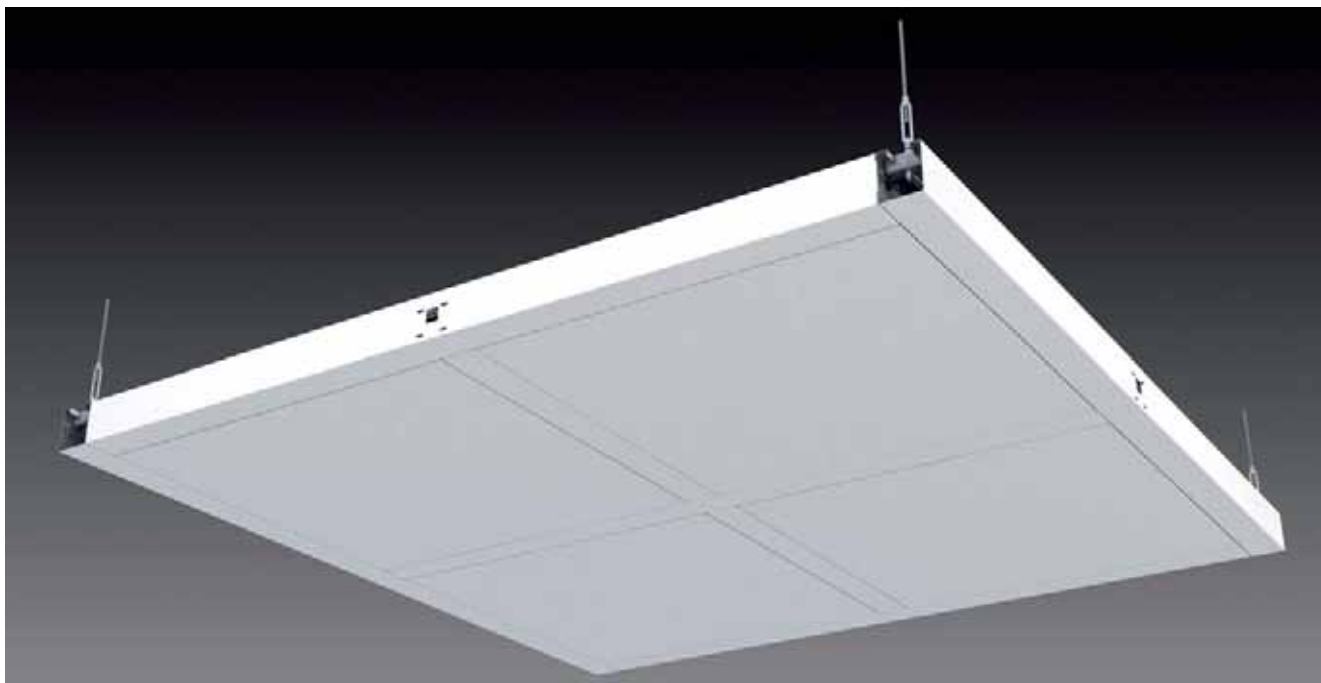

Technical specifications

| | Line 100S type 1 walkable | Line 100S type 2 walkable | Line 100S type 3 non walkable | Line 100S Sandwich walkable |
|---|------------------------------|------------------------------|----------------------------------|---|
| Standard grid dimension ¹⁾ | 1,200 x 1,200 mm | 1,200 x 1,200 mm | 1,200 x 1,200 mm | 2,400 x 1,200 mm |
| Maximum suspension distance ²⁾ | 2,400 x 1,200 mm | 2,400 x 2,400 mm | 1,200 x 1,200 mm | 2,600 x 1,300 mm |
| Maximum suspension height | As required | As required | As required | As required |
| System weight ³⁾ | up to 60 kg/m ² | up to 50 kg/m ² | up to 15 kg/m ² | up to 120 kg/m ² |
| System height | 100 mm | 120 mm | 30 mm | 80 mm |
| Grid width | 100 mm | 100 mm | 100 mm | 100 mm |
| Maximum distributed load | 150 kg/m ² | 100 kg/m ² | - | 220 kg/m ² |
| Maximum point load | 150 kg | 150 kg | - | 150 kg |
| Fire protection class | F0 | F0 | F0 | F0 |
| Inlay | - | - | - | Mineral wool up to 150 kg/m ³ |
| Joint width | 3 mm | 3 mm | 3 mm | 3 mm |
| Service and maintenance access | From above and below | From above | From below | From above |

1) Special grid dimensions on request

2) Dependent on individual weight and additional load

3) Dependent on system requirements

Line 100S Sandwich

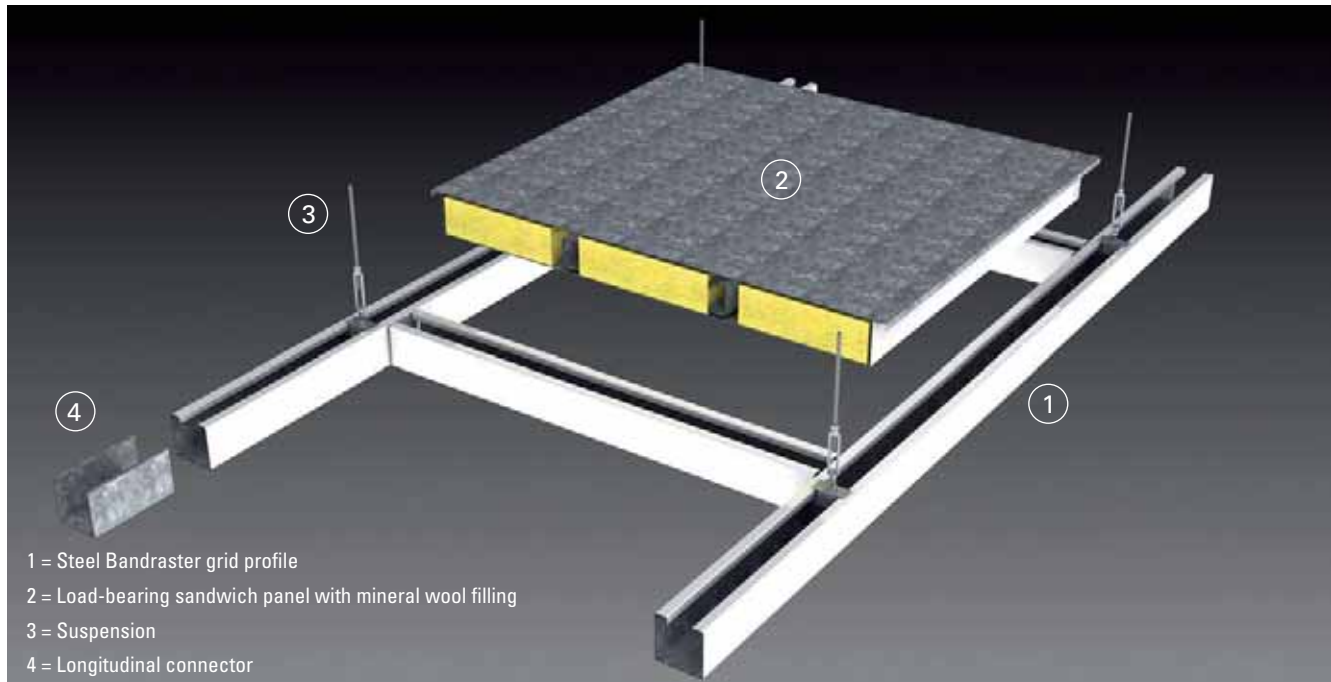

Materials

| Grid | Ceiling panels |
|------------------------|------------------------|
| Steel, stainless steel | Steel, stainless steel |

Grid heights

| Model | Main grid | Post cap cross noggin grid |
|----------|-----------|----------------------------|
| Type 1 | 100 mm | 30 mm |
| Type 2 | 120 mm | 120 mm |
| Type 3 | 30 mm | 30 mm |
| Sandwich | 80 mm | 80 mm |

Accessories

- Grid covering for homogenous load-bearing surfaces
- Clean room suitable inspection hatch
- Clean room suitable smoke and heat extraction hatches (SHE hatches)
- Vibration joint

Options

- Factory assembled cavities for cable and media feed-through
- Mineral wool inlays for improving sound insulation properties
- Factory assembled cut-out for integrated components such as lights, ceiling outlets etc.
- Sliding wall connections in various designs
- Clean room suitable sealants

Special features



- Easy to clean
- Resistant to a variety of cleaning and disinfection agents on the VAH list (The Association for Applied Hygiene)



Ceiling available in walkable versions



Quality standards

Surfaces see page 60

Product characteristics

- High structural load-bearing capacity
- Compatible with the Lindner LVT 100 wall system
- Highest level of load-bearing comfort when installed as a sandwich version
- Concealed media feed-throughs (also inside the sandwich panels)
- Clean room lights type LP can be invisibly integrated into the ceiling panel in the grey room¹⁾
- Available completely in stainless steel
- Various material and designs
- Minimum number of suspension points
- Various grid dimensions available
- All designs are flush

1) Only for systems with heights of 100 mm and 120 mm

Crossdata 55A

The junction system Crossdata 55A has been specially designed for use in microelectronic areas. It provides the highest level of flexibility and is easy to assemble. Due to the minimal number of component parts and very good technical properties, this ceiling system can be extensively and economically used in many industries including the optical industry, surface technology, microsystem technology or precision mechanics engineering.



Technical specifications

| | Crossdata 55A non walkable | Crossdata 55ALine 100A walkable |
|---|---------------------------------------|--|
| Standard grid dimension ¹⁾ | 1,200 x 1,200 mm | 1,200 x 1,200 mm |
| Maximum suspension distance ²⁾ | 2,400 x 1,200 mm | 1,200 x 1,200 mm |
| Maximum suspension height | As required | As required |
| System weight ³⁾ | up to 20 kg/m ² | up to 50 kg/m ² |
| System height | 80 mm | 80 mm |
| Grid width | 55 mm | 55 mm |
| Maximum distributed load | - | 150 kg/m ² |
| Maximum point load | - | 150 kg |
| Fire protection class | F0 | F0 |
| Joint width ⁴⁾ | 0.5 mm* or 2.5 mm** | 0.5 mm* or 2.5 mm** |
| Service and maintenance access | From below | From above and below |

1) Special grid dimensions on request

2) Dependent on individual weight and additional load

3) Dependent on system requirements

4) Joints *unsealed and/or **sealed

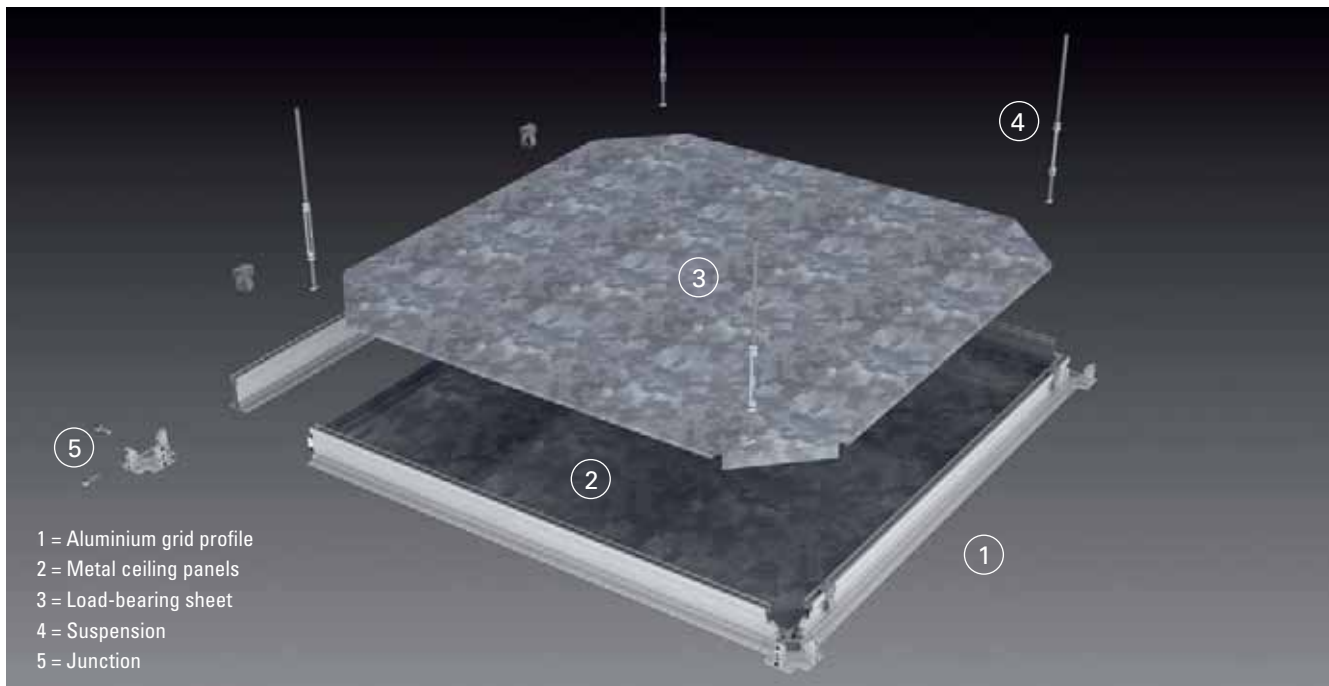

Materials

Grid

Aluminium

Ceiling panels

Steel, stainless steel or aluminium

Accessories

- Clean room suitable inspection hatch
- Clean room suitable smoke and heat extraction hatches (SHE hatches)
- Vibration joint

Options

- Factory assembled cavities for cable and media feed-through
- Mineral wool inlays for improving sound insulation properties
- Factory assembled cut-out for integrated components such as lights, ceiling outlets etc.
- Sliding wall connections in various designs
- Clean room suitable sealants
- Ceiling panels available in either flush or non-flush versions

Special features



This system is suitable for use in the electronic industry.



Quality standards



Ceiling available in walkable versions

Surfaces see page 60

Product characteristics

- High structural load-bearing capacity
- Fully compatible with the ceiling system Line 55A
- Can be installed as a plenum ceiling
- Compatible with wall system Variodata 50 and access floor system PRODATA
- Ceiling panels available in various materials and designs
- Best suited for completely flat FFUs¹⁾

1) FFU Filter Fan Unit

Clip SK / K15

The Clip SK/K15 clip-in cassette ceiling is a complete clean room system which has already proven itself hundreds of times in various clean room applications. The Clip system, which is compatible with all current built-in components such as lights, outlets, sprinklers etc, provides solutions for numerous areas of application. The ceiling cassettes are available with and without bevels and optionally in a clip-in or clip-in/fold-down design.

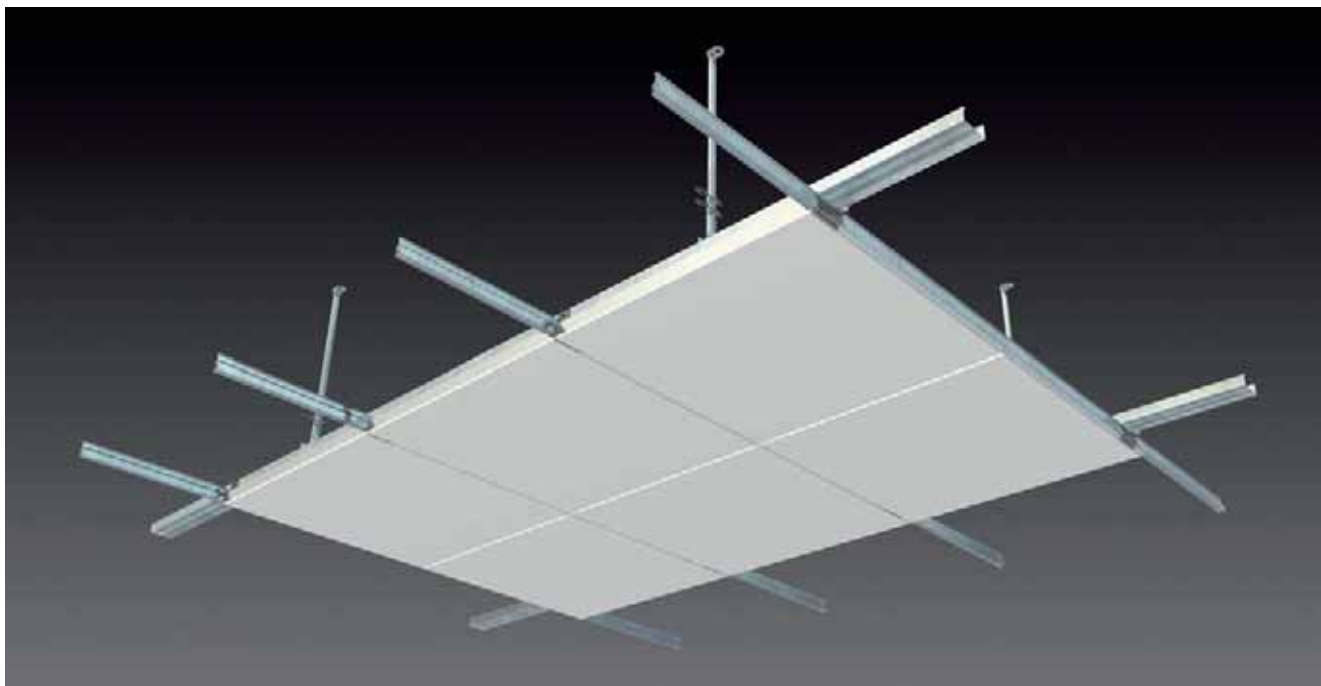

Technical specifications

| | Clip SK | Clip K15 |
|---|------------------------------|------------------------------|
| Standard grid dimension ¹⁾ | 600 x 600 mm 625 x 625 mm | 600 x 600 mm 625 x 625 mm |
| Maximum suspension distance ²⁾ | 1,300 x 1,300 mm | 1,300 x 1,300 mm |
| Maximum suspension height | From 90 mm | From 80 mm |
| System weight ³⁾ | up to 10 kg/m ² | up to 10 kg/m ² |
| System height | 83 mm | 72 mm |
| Edge design on visible side | 90°, without bevels | 45°, with bevels |
| Maximum approved vacuum | 25 Pa | 25 Pa |
| Maximum point load | - | - |
| Fire protection class | F0 | F0 |
| Joint width | approx. 1 mm | approx. 7 mm |
| Service and maintenance access | From below | From below |

1) Special grid dimensions on request

2) Dependent on individual weight and additional load

3) Dependent on system requirements

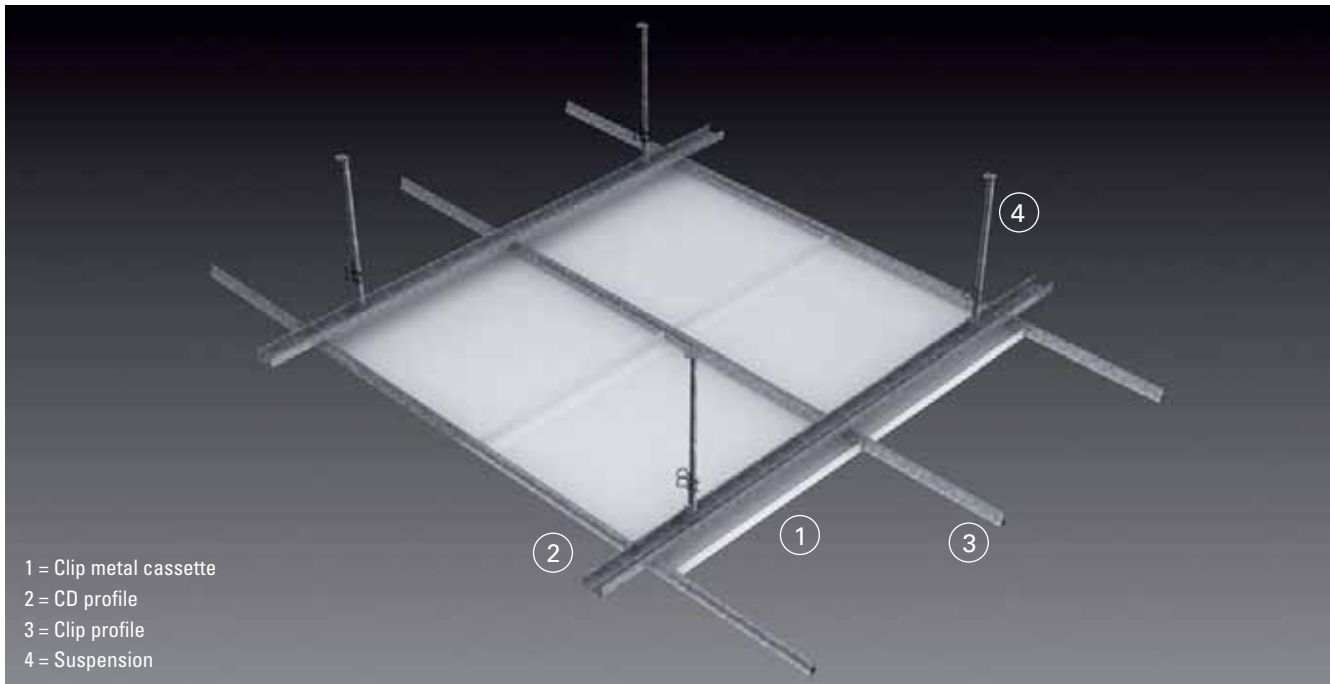

Materials

Substructure

Steel

Ceiling panels

Steel, stainless steel or aluminium

Accessories

- Clean room suitable inspection hatch
- Clean room suitable smoke and heat extraction hatches (SHE hatches)

Options

- Factory assembled cut-out for integrated components such as lights, ceiling outlets etc.
- Sliding wall connections in various designs
- Clean room suitable sealants

Special features



- Easy to clean
- Resistant to a variety of cleaning and disinfection agents on the VAH list (The Association for Applied Hygiene)



Quality standards



Surfaces see page 60

Product characteristics

- Economically priced
- Minimal number of joints
- Lightweight
- Easy to assemble and dismantle
- Completely flush
- Homogenous surface
- Joints can be easily sealed



Lindner Clean Room Walls

Flexible and reliable.

Are you looking for a product that can be adjusted to spatial changes at any time?

With their modular design, individual elements of Lindner Clean Room Walls can be easily relocated or replaced even after assembly.

Our clean room walls are also available as special tailor-made solutions: for example as fire protection, sound insulation or radiation protection as well as flush-mounted. Of course all our wall systems can be easily combined with our flooring and ceiling systems.



Meda Pharma, Bad Homburg

Areas of application

- Pharmacy and medical technology
- Electronic and semiconductor technology
- Microsystems & precision mechanical engineering and optics.
- Operating theatre technology
- Laboratories
- Food technology
- Computer rooms and control centres
- Surface treatment technology

Lindner LVT 100

The clean room wall system Lindner LVT 100 is best suited for use in clean rooms and in operating theatres. With its wide range of designs it can be installed in many areas such as laboratories and clinics as well as electronic, explosion-proof and radiation protection areas.



Product characteristics

- Easy to dismantle and reassemble
- Easy access handling for neighbouring installations
- Can be combined with all LVT glazing designs
- Compatible with Lindner Floor and Ceiling Systems
- Easy to lay cables and pipes in the wall cavity
- Thermowall wall heating can also be integrated



LTS Lohmann, Andernach

Technical specifications

| | | |
|--|---|---|
| Wall thickness | 100 mm | |
| Joint widths | 4 mm (each component can be optionally sealed depending on clean room standards) | |
| Width (distance between axes) | up to 1,450 mm (depending on area of installation) | |
| Wall heights | up to 5,000 mm (depending on area of installation) | |
| System weight (solid partition) | 38 - 42 kg/m ² | |
| Sound insulation  | Solid partition: up to 54 dB R _{w,P} | Glazing: up to 49 dB R _{w,P} |
| | Tested to DIN EN ISO 140-03 | |
| Fire protection  | Solid partition: - F0 - F30 ¹⁾ - F90 ¹⁾ - EI30 ²⁾ - EI60 ²⁾ | Glazing: - F0 - F30 ¹⁾ - EI30 ²⁾ - EI60 ²⁾ |
| | 1) Tested to DIN 4102 2) Tested to DIN 13501-2 | |

Materials

- Wall panels**
(Shell construction with hook-on system)
Steel sheet (standard):
- Coil-coating
 - Powder coating as per RAL

Stainless steel
Smooth or brushed

Accessories

- Glazing
- One or two-winged swing doors, sliding doors, rolling shutters, rapid action doors or entrance ways.
- Material or document locks
- Maintenance openings for retrospective installation
- Integral cable channel

Substructure

Consists of canted and/or rolled steel sheet profiles, galvanised or varnished

For integral glazing systems see page 30

Surfaces see page 60

Special features



- Easy to clean
- Resistant to a variety of cleaning and disinfection agents on the VAH list (The Association for Applied Hygiene)



Suitable for use in radiation protection areas due to optional, additional lead lamination on the inside



Sandwich 60P and 80P

The clean room wall systems Sandwich 60P and 80P are perfect for use in clean rooms. These sandwich panels consist of different metal substructures with various fillings.

Product characteristics

- Easy to dismantle and reassemble
- Easy to move
- Small number of components
- Combinable with Lindner glazing options
- Compatible with Lindner glazing options and with Lindner Floor and Ceiling Systems
- Lightweight



Silicon Sensor, Berlin

Technical specifications

| | | |
|---------------------------------|--|-------------------------|
| Wall thickness | 60P = 60 mm; 80P = 80 mm | |
| Joint widths | 3 mm (each component can be optionally sealed depending on clean room standards) | |
| Width (distance between axes) | up to 1,200 mm (depending on area of installation) | |
| Wall heights (solid partition) | up to 3,200 mm (depending on area of installation) | |
| System weight (solid partition) | approx. 15 - 22 kg/m ² depending on the sandwich filling | |
| System weight (glazing) | approx. 35 kg/m ² | |
| Fire protection | Solid partition: - F0 | Glazing: - F0 |

Materials

Wall panels

Steel sheet (standard)

- Powder coating as per RAL
- Coil-coating

Aluminium

- Powder coating as per RAL

Stainless steel

- Smooth or brushed

Filling material for wall panels

Polystyrene building materials class B1

Bonded rock wool building materials class A1

Aluminium honeycomb core building materials class A1

- Overflow grids
- Integral cable channel
- Empty pipes for electronics installation

Substructure

The sandwich panel is connected by means of a square, aluminium, internal pipe.

For integral glazing systems see page 30

Surfaces see page 60

Special features



- Easy to clean
- Resistant to a variety of cleaning and disinfection agents on the VAH list (The Association for Applied Hygiene)

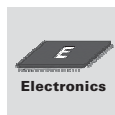

This system is suitable for use in the electronics industry.

Accessories

- Balustrade glazing
- One or two-winged swing doors, sliding doors, rolling shutters, rapid action doors or entrance ways.
- Material or document locks



- 1 = Fixing dowel
- 2 = Overhang ceiling profile
- 3 = Fixing connection
- 4 = Sandwich element
- 5 = Height-adjustable floor profile

Variodata 50

The clean room wall system Variodata 50 has been specially designed for use in the microelectronics and semi-conductor industries. The cross-bar construction with clipped in infill is extremely flexible to assemble and dismantle and is suitable for many technological applications.

Product characteristics

- Easy to disassemble and reassemble
- Easy to move
- Flexible system for replacing/interchanging elements
- Combinable with Lindner glazing options
- Compatible with Lindner glazing options and with Lindner Floor and Ceiling System e.g. PRODATA and Crossdata 55A
- Lightweight



MST Factory, Dortmund

Technical specifications

| | | |
|-------------------------------|--|-------------------------|
| Wall thickness | 50 mm | |
| Width (distance between axes) | up to 1,250 mm (depending on area of installation) | |
| Wall heights | up to 4,200 mm (depending on area of installation) | |
| Fire protection | Solid partition: - F0 | Glazing: - F0 |

Materials

Wall panels shell construction with clip system

Steel sheet

- Powder coating as per RAL
- Coil-coating

Aluminium sheeting

- Powder coating as per RAL
- Anodised

Sandwich element filling

Polystyrene building materials class B1

Bonded rock wool building materials class A1

Aluminium honeycomb core building materials class A1

Balustrade glazing:

- Float, ESG¹⁾ or VSG²⁾
- One or multi-layer construction
- Thickness: 6 – 9 mm

Surfaces see page 60

Special features

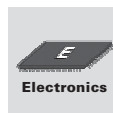

This system is suitable for use in the electronics industry.

1) ESG = tempered safety glass

2) VSG = laminated safety glass

Accessories

- Balustrade glazing
- One or two-winged swing doors, sliding doors, rolling shutters, rapid action doors or entrance ways.
- Material or document locks
- Overflow grids



- | | |
|------------------------------|-------------------------------|
| 1 = Fixing dowel | 7 = Clamp spring |
| 2 = Overhang ceiling profile | 8 = Sandwich element |
| 3 = H-lateral bar | 9 = U-lateral bar |
| 4 = System stand | 10 = Height adjustment |
| 5 = Clamping strip | 11 = Floor connection profile |
| 6 = Insulating glass | |

Type A



Type B



Antisept OP

The clean room wall system Antisept OP has been specially designed for installation in high quality operating theatres. The wall panels can be constructed from various materials such as stainless steel, steel or aluminium. The core of the panels consists of aluminium honeycomb.

A highlight of the system is its integral glazing, which can be designed in colour and supplied with additional LED background lighting.

Product characteristics

- Easy to disassemble and reassemble
- Easy to move
- Full frameless glazing (cut-outs for built-in accessories possible)
- Cut-outs for retrospective installation is possible at any time
- Self-supporting system



BrainLAB BrainSuite, Singapore
Images courtesy of Singapore GH

Technical specifications

| | |
|-------------------------------|--|
| Wall thickness | 30 mm |
| Joint width | 3 mm (each component can be optionally sealed depending on clean room standards) |
| Width (distance between axes) | 1,000 - 1,200 mm |
| Wall heights | up to 3,200 mm |
| Fire protection | F0 |

Materials

Wall panels (shell construction)

Steel sheet

- Powder coating as per RAL
- Coil-coating

Stainless steel: Smooth or brushed

Accessories

- Maintenance hatches
- Flush screens
- Ventilation grids/outlets
- Windows
- Changeable media adapters (for gas, plugs etc)
- Integrated cupboards

Integral glazing:

- Self-supporting multi-layer construction
- Opaque, coloured foil inside
- Cavities are possible

Special features



- Easy to clean
- Resistant to a variety of cleaning and disinfection agents on the VAH list (The Association for Applied Hygiene)



- Suitable for use in radiation protection areas due to optional, additional lead lamination on the inside

Wall panels with an integrated display



Full glazing without frames



Full Glass Wall

The clean room glass wall has been specially developed for use in the pharmaceutical industry. It provides excellent transparency into the production areas and is therefore often installed for visitors and/or for maintenance purposes. As constant traffic passes through the production rooms this wall system can be integrated with scratch protection.

Product characteristics

- High level of transparency thanks to the extensive use of glass
- The wall can be combined with Lindner Floor and Ceiling Systems
- Integral scratch protection
- Meets high level of aesthetics



Merckle ratiopharm, Weiler

Technical specifications

| | |
|-------------------------------|--|
| Wall thickness | From 12 mm (depending on the thickness and the type of the glass) |
| Joint width | 4 mm (each component can be optionally sealed depending on clean room standards) |
| Width (distance between axes) | 1,000 - 2,500 mm |
| Wall heights | up to 3,200 mm |
| Fire protection | F0 |

Glass elements

- ESG¹⁾ and VSG²⁾ panes; pane thickness from 12 mm
- Cavities are possible
- Visual design with silk-screen printing or foils

Special features



- Easy to clean
- Resistant to a variety of cleaning and disinfection agents on the VAH list (The Association for Applied Hygiene)

1) ESG = tempered safety glass

2) VSG = laminated safety glass

Accessories

- Scratch protection
- One or two-winged swing doors and sliding door



- 1 = Floor profile with scratch protection
- 2 = Glass element
- 3 = Ceiling profile

Laboratory Walls

The wall system Lab is characterised by its flexibility and modularity – particularly when it comes to installing services and being easy to maintain. It also stands out because of its height adjustable laboratory equipment and the fact that it can be installed in various ways e.g. at half-height, room-height or as a framework wall construction. Its construction means that a high level of stability and load-bearing capacity is achieved.

Product characteristics

- High load-bearing capacity
- Easy to maintain service shafts
- Height adjustable laboratory furniture



NFI - Netherlands Forensic Institute, The Hague

Technical specifications

| | |
|-------------------------------|--|
| Wall thickness | From 100 mm |
| Joint width | 4 mm (each component can be optionally sealed depending on clean room standards) |
| Width (distance between axes) | up to 1,500 mm |
| Wall heights | Adjustable depending on type |
| System weight | Various – construction limited between 35 - 70 kg/m ² |
| Fire protection | F0 |
| Sound insulation | up to 44 dB R _{w,p} , DIN EN ISO 140-03 compliant |
| Radiation protection | Available on request |
| Load-bearing capacity | 1.6 kN/m (depending on design) |

Materials

Wall panels

- Anodised or powder-coated aluminium
- Smooth or brushed stainless steel
- Powder-coated steel sheet
- HPL (High Pressure Laminate) composite panels

Runners

- Anodised aluminium

Substructure

Steel pedestals with corresponding openings for installing services.

Wall panels

Wall elements with flaps or clips

Shelving/organisation and table systems

Attached to the vertical runners and can be adjusted in height depending on your requirements.

Built-in fittings

- System furniture
- Media supplies
- Special equipment for laboratories

Laboratory wall type Lab1



NFI - Netherlands Forensic Institute, The Hague

Laboratory wall type Lab2



University, Amsterdam

Laboratory wall type Lab3



NFI - Netherlands Forensic Institute, The Hague

Glazing

LVT System Glazing



| | Type LM 437 |
|-------------------------------|---|
| Glazing thickness | 100 mm |
| Width (distance between axes) | up to 1,450 mm |
| Wall heights | up to 3,500 mm (single element 3,000 mm) |
| Weight | 35 - 40 kg/m ² as a complete glass wall |
| Sound insulation | up to 49 dB R _{w,P} DIN EN ISO 140-03 compliant |
| Fire protection | F30 as per DIN 4102 EI30 as per EN 13501-2 EI60 as per EN 13501-2 |
| Joint widths | Steel sheet (standard) |
| Pane type and thickness | 6 mm or 8 mm ESG ¹⁾ , VSG ²⁾ , Float |
| Adhesive | Type: Structural glazing method to ETAG 002 Temperature resistance: -50° C – 150° C Colour: light grey |



| | Type LM 438 |
|-------------------------------|--|
| Glazing thickness | 100 mm |
| Width (distance between axes) | up to 1,200 mm |
| Wall heights | up to 3,500 mm (undivided 3,000 mm) |
| Weight | 35 - 40 kg/m ² as a complete glass wall |
| Sound insulation | up to 41 dB R _{w,P} DIN EN ISO 140-03 compliant |
| Fire protection | F0 |
| Joint widths | Sheet steel (standard) |
| Pane type and thickness | 6 mm ESG ¹⁾ |
| Adhesive | Adhesive tape Colour: white (standard), anthracite |

Sandwich glazing



| | Balustrade glazing |
|-------------------------------|---|
| Glazing thickness | 60P = 60 mm; 80P = 80 mm |
| Width (distance between axes) | up to 1,200 mm |
| Heights | up to 1,800 mm |
| Weight | 35 kg/m ² |
| Sound insulation | - |
| Fire protection | F0 |
| Joint widths | 3 mm |
| Pane type and thickness | 6 mm ESG ¹⁾ ; VSG ²⁾ Floating option possible |
| Adhesive | Adhesive tape Colour: white (standard), anthracite |

1) ESG tempered safety glass

2) VSG laminated safety glass

Clean Room Doors

1 wing, 2 wing

The tailor-made, high quality clean room doors from Lindner ensure a high degree of impermeability for your clean room. They are entirely made from non-organic materials and fitted with surfaces suitable for clean-rooms, ensuring that all clean-room standards are met.

We also supply doors with all the important fire, smoke and noise protection properties tested to the current EU directives and DIN standards. The highest level of comfort paired with the optimal level of safety.

Product characteristics

- Glass cutout means high level of transparency
- Compatible with Lindner Floor and Ceiling Systems
- Integral scratch protection
- Special components available depending on customer's requirements



Campeon, Neubiberg

Technical specifications

| | 1 wing | 2 wing |
|--|---|---|
| Door leaf thickness | 42 mm | 42 mm |
| External frame dimensions - width ¹⁾ | up to 1,200 mm | up to 2,500 mm |
| External frame dimensions - height ¹⁾ | approx. 2,200 mm | approx. 2,200 mm |
| Frame mirror | Sandwich walls: 55/70 mm LVT 100: 40/55 mm | Sandwich walls: 55/70 mm LVT 100: 40/55 mm |
| Sound insulation | up to 35 dB R _{w,P} tested to DIN EN ISO 140-03 | - |
| Fire protection | T0 | T0 |

1) Special sizes are available.

Variations

- with or without glass cut-out
- with or without panic button
- VX roller belt or screw on belt

Accessories

- E-opener for lock control or access control
- Magnetic clamp for lock control or access control
- Stainless steel scratch protection
- DC / CDC (Door closer/Concealed door closer)
- Door opener

Clean Room Doors

1 wing

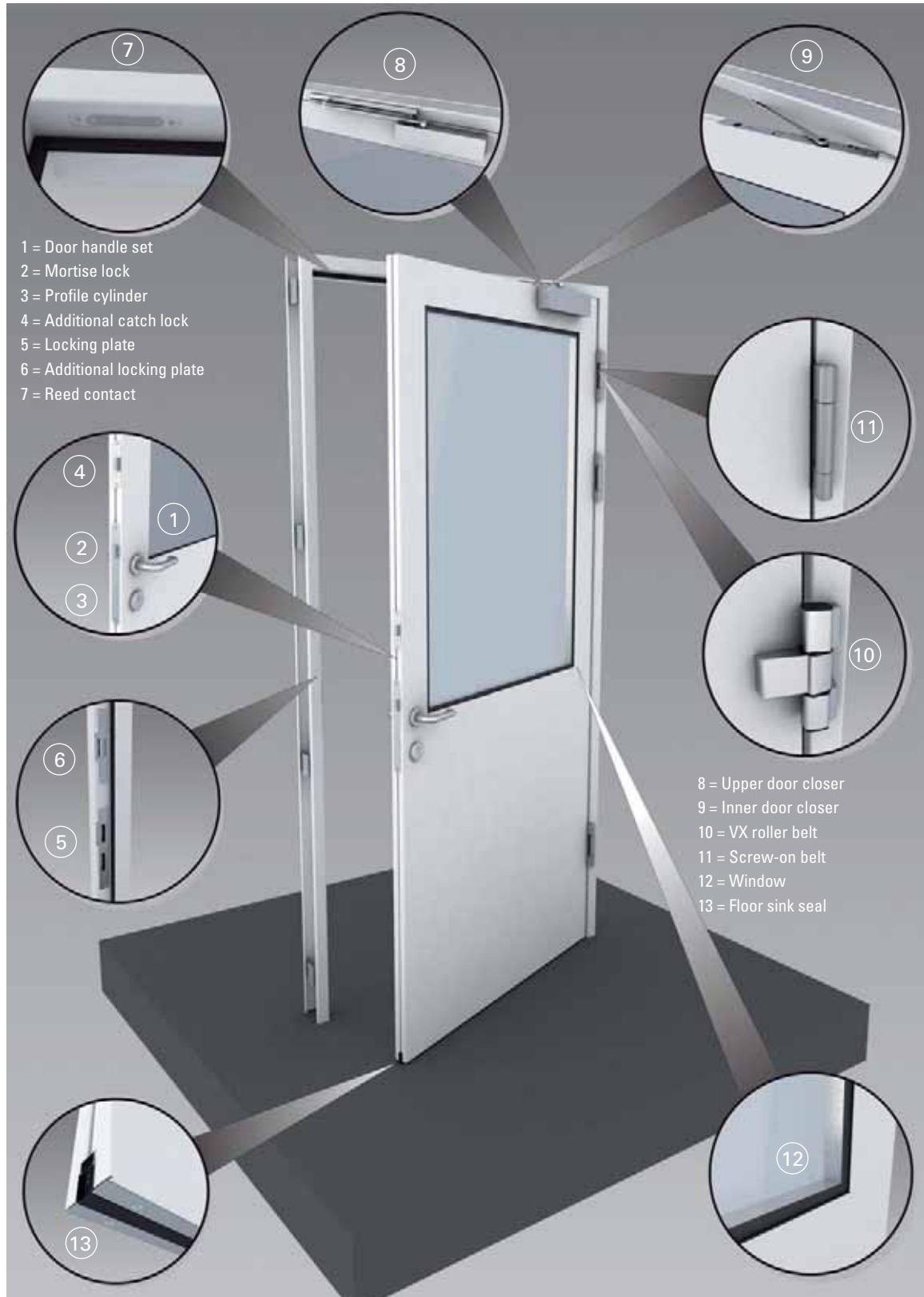

Note: The picture is only for example purposes and also includes some optional components.

Clean Room Doors

2 wing



Note: The picture is only for example purposes and also includes some optional components.

Clean Room doors

Complete glass door

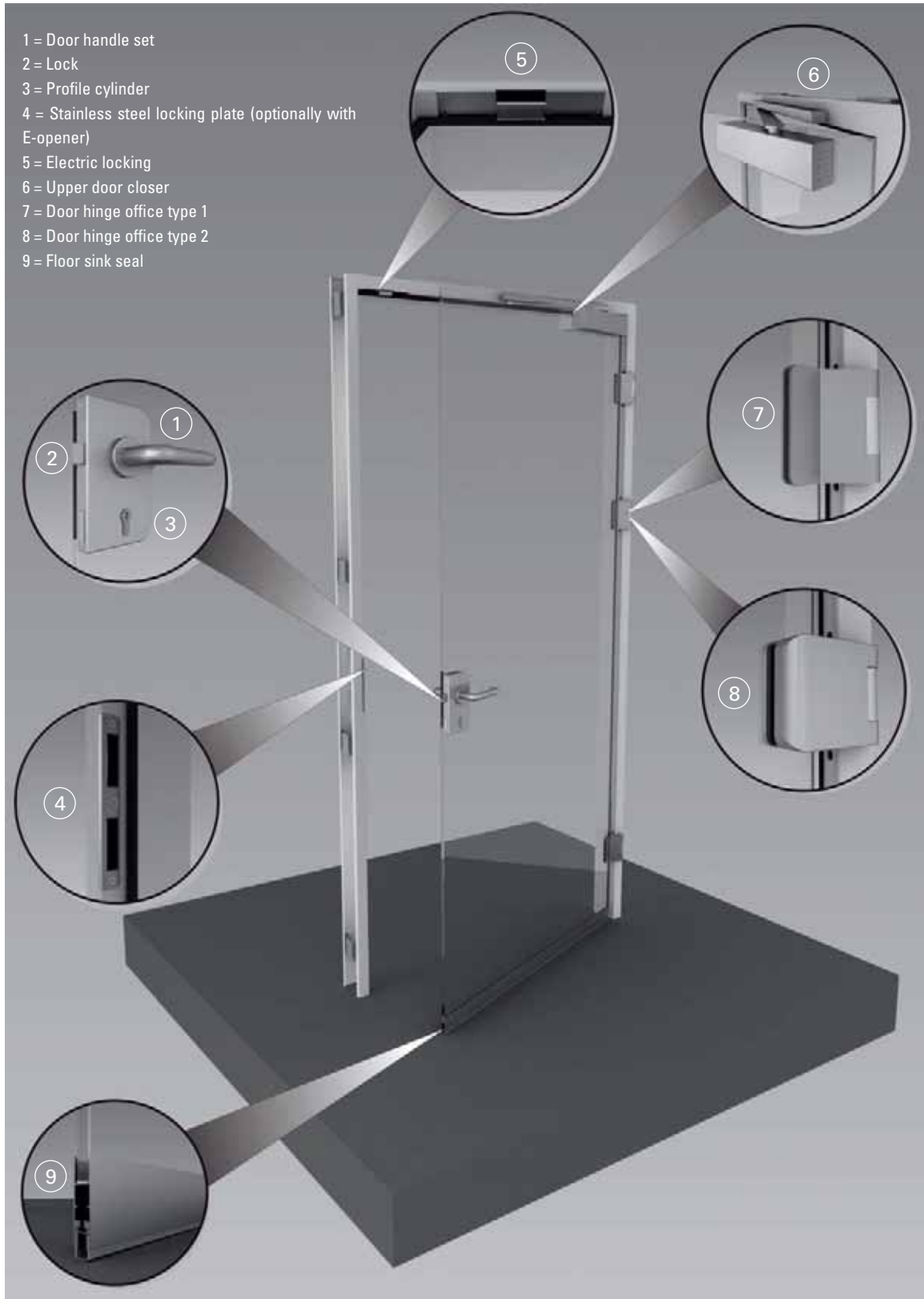

Note: The picture is only for example purposes and also includes some optional components.

Lindner Clean Room Raised Floors

Perfectly tidy.

The load bearing capacity, ventilation and electrostatics of a floor are essential for use in clean rooms. Our raised floors meet all technical requirements when it comes to high-quality clean room solutions. We manufacture your flooring systems with the highest precision and accuracy.

It's not for nothing that we have a worldwide reputation as recognised specialists for clean floor rooms.



Campeon, Neubiberg

Areas of application

- Electronic and semiconductor technology
- Microsystems & precision mechanical engineering and optics.
- Computer rooms and control centres
- Pharmacy and medical technology

PRODATA

The raised floor system PRODATA is a high quality aluminium die cast panel with an orthotropic design and is produced with maximum precision and accuracy.

Its high load-bearing capacity and its abrasion resistance when used for ventilation purposes means that PRODATA is ideal for use in all clean rooms and other areas of application requiring high technical performance.



Technical specifications

| | PRODATA 6500 | PRODATA 7500 | PRODATA 10000 |
|---|---|-----------------------------|-----------------------------|
| Load and adjustment class ¹⁾ | 6 B (6 kN) | 6 B (7 kN) | 6 B (10 kN) |
| Building material class of carrier ²⁾ | A1 | A1 | A1 |
| Resistance to earth ³⁾ | $\geq 1 \times 10^4 \Omega$ | $\geq 1 \times 10^4 \Omega$ | $\geq 1 \times 10^4 \Omega$ |
| System weight ⁴⁾ (with Lindner pedestal systems) | 27 kg/m ² | 27 kg/m ² | 42 kg/m ² |
| Standard finished floor heights ⁵⁾ | 30 – 1,470 mm | | |
| Panel thickness ⁶⁾ | 43.7 mm | 50 mm | 60 mm |
| Pedestal base distance | 600 x 600 mm | 600 x 600 mm | 600 x 600 mm |
| Possible floor coverings | <ul style="list-style-type: none"> - Elastic floor coverings - Textile floor coverings ⁷⁾ - Self-laid tiles | | |

1) Tested to DIN EN 12825, as well as application guidelines with safety factor 2, nominal load in brackets

2) Tested to DIN 4102; A1 (non combustible) 3) Values are influenced by the floor covering

4) At 150 mm above floor level, without covering 5) Clearance height, special heights on request

6) The pre-formed edges allow the height of the panels to be adjusted

7) Outside clean room applications only for use with heavy load floors

Accessories see page 43

System description

Panel properties/surfaces

There is an option to order these panels with factory-bonded floor covering or coating, which can be conductive if required.

Load-bearing capacity

Depending on the panel type product can withstand point loads from 6 - 10 kN can be implemented (according to the usage guidelines DIN EN 12 825)

Resistance to earth

The PRODATA panels are mainly made of aluminium which is very good for electrostatic conductivity. Through the use of highly conductive components e.g. coverings, adhesives and sound insulation panels the electrostatic charge is continuously defused to the earth potential, making selection of the correct surface coating crucial.

System weight

Depending on the customer's requirements regarding load capacity the system weight varies between 27 - 42 kg/m³ (depending on the pedestal heights; weight estimation without covering)

Construction height

For heights of 500 mm plus we recommend horizontal reinforcements with stringers

Pedestal

Pedestals are made from galvanised, yellow chromatised steel and are infinitely adjustable in height. They are equipped with a precision engineered adjustable bolt. Various design types according to height.

Sound dampening plates

Sound dampening gaskets are made of conductive / non-conductive plastics. They support optimum positioning of the floor panels and optimise sound as a result of their material properties.

Adhesive

Pedestal base is glued to subfloor. For static requirements the pedestal is additionally doweled.

Thread locking

Here an additional counternut or alternative locking glue made from a low-emissions material is used.



Wall connection

A permanent, pre-stressed wall connection with sealing tape works as a sound decoupling whilst also absorbing horizontal movements.

Structural subfloor

We recommend a 2-component finish for air-conducting system floors.

Special features



This system is suitable for use in the electronics industry.

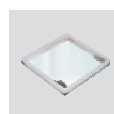

A Plexiglass access panel can be either hinged into or laid into the PRODATA panel for quick access to the floor cavity.

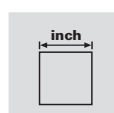

Panels available in inch-dimension.

ALUVENT

Like the PRODATA panel the ventilation panel ALUVENT is high quality aluminium die cast panel with an orthotropic design. By retrospectively drilling holes the PRODATA panel becomes the ALUVENT system, which means that ventilation panels can be made retrospectively from existing full panels, making this a very flexible system. The flexural strength of the panels changes depending on the pattern and the number of holes.



Technical specifications

| | ALUVENT 6500 | ALUVENT 7500 | ALUVENT 10000 |
|---|---|-----------------------------|-----------------------------|
| Load and adjustment class ¹⁾ | 6 B (6 kN) | 6 B (7 kN) | 6 B (10 kN) |
| Building material class of carrier ²⁾ | A1 | A1 | A1 |
| Resistance to earth ³⁾ | $\geq 1 \times 10^4 \Omega$ | $\geq 1 \times 10^4 \Omega$ | $\geq 1 \times 10^4 \Omega$ |
| System weight ⁴⁾ (with Lindner pedestal systems) | 27 kg/m ² | 27 kg/m ² | 42 kg/m ² |
| Standard finished floor heights ⁵⁾ | 30 – 1470 mm | | |
| Panel thickness ⁶⁾ | 43.7 mm | 50 mm | 60 mm |
| Pedestal base distance | 600 x 600 mm | 600 x 600 mm | 600 x 600 mm |
| Possible floor coverings | - Elastic floor coverings - Textile floor coverings ⁷⁾ - Self-laid tiles | | |

1) Tested to DIN EN 12825, as well as application guidelines with safety factor 2, nominal load in brackets

2) Tested to DIN 4102; A1 (non combustible) 3) Values are influenced by the floor covering

4) At 150 mm above floor level, without covering 5) Clearance height, special heights on request

5) Clearance height, special heights on request 6) The pre-formed edges allow the height of the panels to be adjusted

7) Outside clean room applications only for use with heavy load floors

Accessories see page 43

Special features

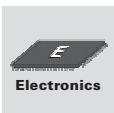

This system is suitable for use in the electronics industry.

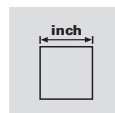

Panels available in inch-dimension.

System description

Description see PRODATA page 37.

Possible hole patterns

| Hole pattern* | ALUVENT 6500 | ALUVENT 7500 | ALUVENT 10000 |
|---------------|--------------|--------------|---------------|
| 256 | X | X | X |
| 512 | X | X | X |
| 1024 | X | X | X |
| 1152 | X | X | X |
| 784 | X | X | X |
| 320 | | | X |
| 640 | | | X |
| 1280 | | | X |

*Hole pattern = number of holes

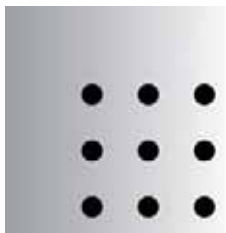
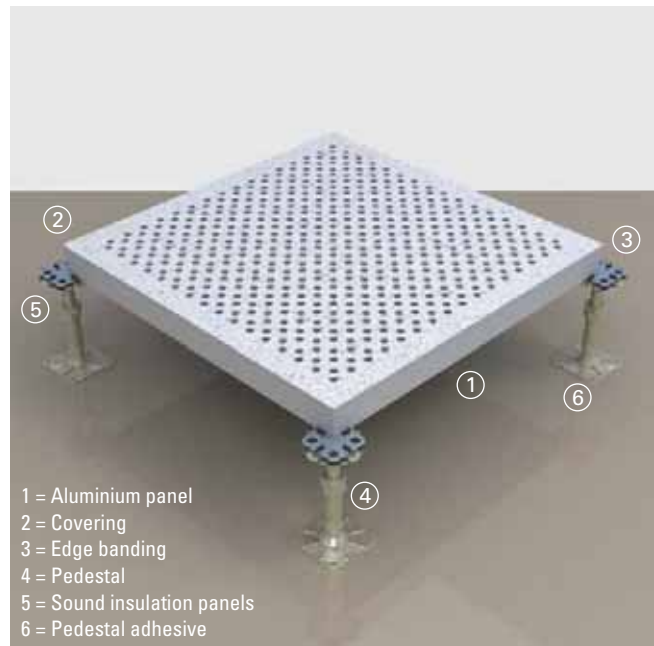

ALUVENT 256
8.4 % open area
with holes Ø 12.3 mm¹⁾



ALUVENT 512
16.9 % open area
with holes Ø 12.3 mm¹⁾

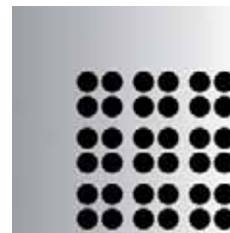

ALUVENT 1024
33.8 % open area
with holes Ø 12.3 mm¹⁾

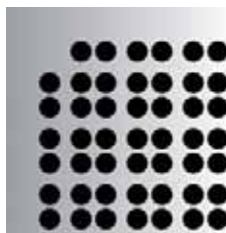

ALUVENT 1152
38 % open area
with holes Ø 12.3 mm¹⁾

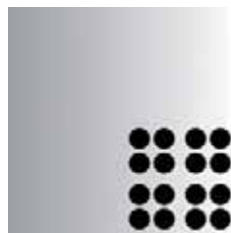

ALUVENT 784
25.9 % open area
with holes Ø 12.3 mm¹⁾

1) for standard holes,
other different diameters available;
panel format 600 x 600 mm

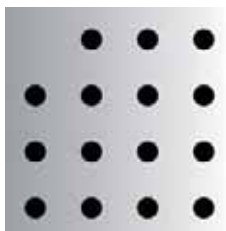

ALUVENT 320
10.6 % open area
with holes Ø 12.3 mm¹⁾

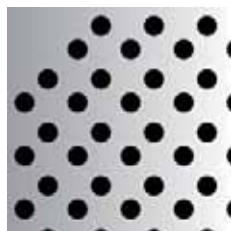

ALUVENT 640
21.1 % open area
with holes Ø 12.3 mm¹⁾

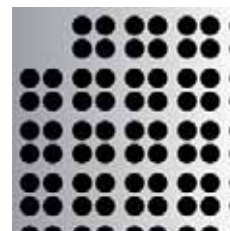

ALUVENT 1280
42.2 % open area
with holes Ø 12.3 mm¹⁾

The holes in the ALUVENT panels are made as standard with a small chamfer. They can be made with bigger chamfers or without chamfers.

The flexural strength of the panels changes depending on the pattern and the number of holes.

OCTOGRATE

The raised floor system OCTOGRATE 7500 is a high quality aluminium die cast panel with an orthotropic design and is produced with maximum precision and accuracy and, as a rule, covered with a conductive coating. With an open area of more than 53% OCTOGRATE 7500 has been specially designed for clean rooms where work is carried out with extremely high amounts of air yet little loss of pressure. These properties make OCTOGRATE 7500 ideal for use in clean rooms up to and including class ISO 3 (DIN EN ISO 14644-1).



Technical specifications

| | OCTOGRATE 7500 |
|--|---|
| Load and adjustment class ¹ | 6 B (7 kN) |
| Building material class of carrier ² | A1 |
| Resistance to earth ³ | $\geq 1 \times 10^4 \Omega$ |
| System weight ⁴ (with Lindner pedestal systems) | 31 kg/m ² |
| Standard finished floor heights ⁵ | 30 - 750 mm |
| Panel thickness ⁶ | 62 mm |
| Pedestal base distance | 600 x 600 mm |
| Possible floor coverings | - no covering possible - conductive or non-conductive powder coating |

1) Tested to DIN EN 12825, as well as application guidelines with safety factor 2, nominal load in brackets

2) Tested to DIN 4102; A1 (non-combustible) 3) Values are influenced by the floor covering

4) At 150 mm above floor level, without covering 5) Clearance height, special heights on request

6) The pre-formed edges allow the height of the panels to be adjusted

Accessories see page 43

Special features



This system is suitable for use in the electronics industry.

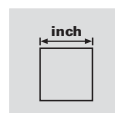

Panels available in inch-dimension.

System description

Panel properties/surfaces

With its large octagonal openings an open area of more than 53% (grid 600 x 600 mm) can be achieved.

Load-bearing capacity

Product can withstand point loads of 7 kN (according to the usage guideline DIN EN 12 825)

Resistance to earth

The OCTOGRATE panels are mainly made of aluminium which is very good for electrostatic conductivity. Through the use of highly conductive components e.g. coverings, adhesives and sound insulation panels the electrostatic charge is continuously defused to the earth potential, making selection of the correct surface coating crucial.

System weight

Depending on the customer's requirements regarding load capacity the system weighs approx. 31 kg/m³ (depending on the pedestal heights; weight increase without coating)

Construction height

For heights of 500 mm plus we recommend horizontal reinforcements with stringers

Pedestal

Pedestals are made from galvanised, yellow chromatised steel and are infinitely adjustable in height. They are equipped with a precision engineered adjustable bolt. Various design types according to height.

Sound dampening plates

Sound dampening gaskets are made of conductive /non-conductive plastics. They support optimum positioning of the floor panels and optimise sound as a result of their material properties.

Adhesive

Pedestal base is glued to subfloor. For static requirements the pedestal is additionally doweled.

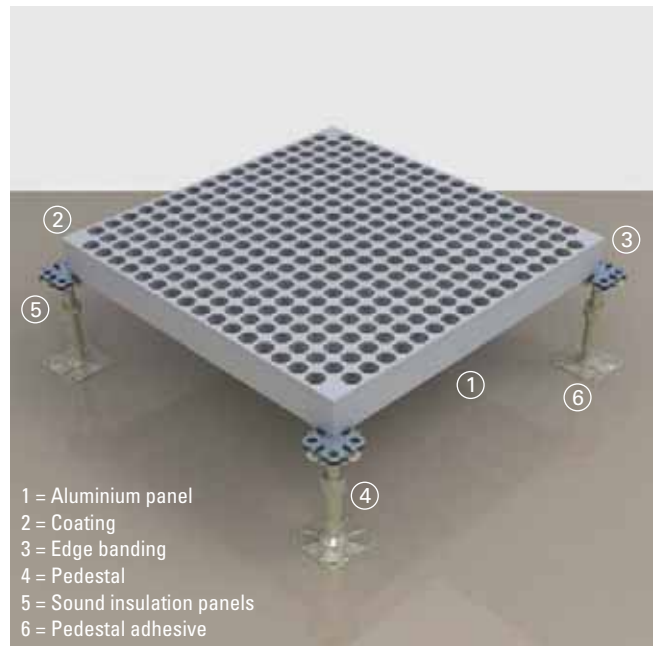

Thread locking

Here an additional counternut or alternative locking glue made from a low-emissions material is used.

Wall connection

A permanent, pre-stressed wall connection with sealing tape works as a sound decoupling whilst also absorbing horizontal movements.

Structural subfloor

We recommend a 2-component finish for air-conducting system floors.

Substructure

Pedestals

The substructure is an important component of every system floor. The pedestals create the cavity needed to accommodate the services. Lindner metal pedestals can be adjusted infinitely on height, therefore compensating for any unevenness in the subfloor. From design to manufacture – we produce our pedestal range entirely in-house.

We manufacture highly accurate pedestals for raised floors. Our many years of experience ensure high load-bearing capacity and excellent durability for all our products. Lindner systems can be combined with one another in many ways, and supplemented with different reinforcement profiles.



Stringers

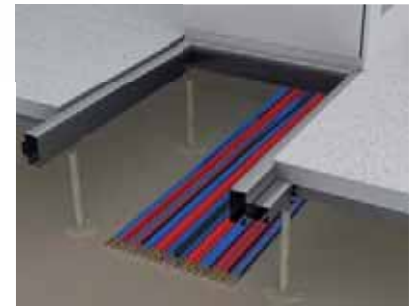

C-profiles

Reinforcement profiles

Lindner Floor Systems feature great load bearing capacities as standard. If this is not enough reinforcement profiles can be added to the system. There is a wide range, from lightweight stringers which increase the horizontal rigidity, through to C-profiles.

Stringers

| | |
|---|--|
| <p>Type RO (Height: 7.5 mm)</p> | <p>The type RO stringer is made from cold-rolled galvanised steel sheet with clip function. Clipping (screwing optional) ensures a firm hold on the pedestal head, thus preventing any noise, for example rattling. The sole purpose of the stringer is to reinforce the system horizontally.</p> |
| <p>Type RL (Height: 35 mm)</p> <p>Type RM (Height: 54 mm)</p> | <p>Type RL (light) and type RM (medium) stringers are made from cold-rolled galvanised steel sheet. Springs are inserted laterally on the ends of the stringers which are then clipped into the pedestal from above by pressing downwards (screwing optional). RL and RM stringer are used for horizontal and vertical system reinforcement.</p> |

C-profiles

| | |
|---------------------------------|---|
| <p>Type CL (Height: 41 mm)</p> | <p>Cold-rolled galvanised steel sheet, for use in switch room construction. Profiles are installed lengthwise in a continuous line underneath the floor using a hammerhead screw or a spring clip. A significant increase in load can be achieved depending on the dimension of the C-profile being used.</p> |
| <p>Type CS (Height: 41 mm)</p> | |
| <p>Type CM (Height: 84 mm)</p> | |
| <p>Type CH (Height: 126 mm)</p> | |

System Accessories

Cavity barriers

In air-ventilating clean room floors there will be requirements regarding the air-tightness of the floor cavity which will result in the need for integrating compartments.

There are many options, enough to suit all requirements.



Facings

Staircases, platforms, etc. need to be finished with a front cladding (facing). Where features such as free-standing borders are required, the top edges of the facing will be protected with a stair edging profile. Angles screwed to the subfloor and bracings installed in the upper area of the facing ensure a stable structure.



Electrical outlets

As all electrical installations are fed under the raised flooring, electrical connections can be placed exactly where you want them by the installation of electrical outlets.



Intermediate floor for cables

Where there is a lot of cabling, additional installation elements will be required. An intermediate floor should be installed to carry cables; this will also improve the horizontal stability of the system.



Expansion joints

Expansion joints are used to absorb horizontal deflections and vertical weighing down.



Further components are available on request.



Lindner Clean Room Lights

A real highlight.

Clean room applications make particularly heavy demands on lighting strength and the sealing of luminaires. Lindner clean room lights are compatible with all clean room ceilings and are adjusted to the requirements of your room through our lighting calculations. You will take delivery of integrated and surface-mounted lights which comply with the highest clean room requirements - the highlight of your project.



DHU, German Homeopathy Union, Karlsruhe

Areas of application

- Pharmacy and medical technology
- Electronic and semiconductor technology
- Microsystems & precision mechanical engineering and optics.
- OP technology
- Laboratories
- Food technology
- Computer rooms and control centres
- Surface treatment technology

Clean Room Light LP

Compact, integrated lights made of powder-coated steel sheeting for flush installation. LP lights fulfill all the requirements of clean room lighting. The lights have been designed for clean rooms taking into account the highest hygienic requirements and are characterised by their seamless connection with the adjacent ceiling panel. The glass panes are held in place with an adhesive covering the edge of the frame and are fixed on securely by means of a mounting bracket. The frame is held in the housing by means of a clamped clip fastening. The LP lighting system can be integrated into clip-in cassette and exposed grid ceiling systems as well as into ceiling panel cut-outs. An integrated closed-cell sealant ensures the necessary air-tightness of the lights.



1 = Housing for light fitting
2 = Frame
3 = 3-pin connection cable

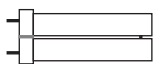

TC-L Lamp

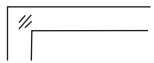

Edge design



Protection class



IP protection

Special features



Optionally as emergency lighting

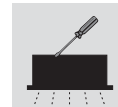

Operation from above optional



With parabolic mirror



Technical specifications¹⁾

| | |
|--------------------------|------------------------------|
| Dimensions | 600 x 600 mm or 625 x 625 mm |
| Lighting height | 90 mm |
| Attachment to suspension | Riveting nut M5, on the side |
| Maintenance | From below (room side) |
| Material | Steel powder-coated |
| Colour | RAL 9016 |
| Voltage | 230 Volt / 50 Hz |
| Protection class | I |

| | |
|---------------------|--------------------------------------|
| Protective system | IP 65 (downwards) IP 54 (upwards) |
| Ballast | Electronic ballast |
| Reflectors | Standard with Parabolic mirror |
| Lamp | 2 x TC-L 55 W |
| Lamp colour | Neutral white 840 |
| Finishing material | Clear ESG |
| Connection | 3-pin connection cable |
| Connection location | On the side |

1) The specifications are valid for the standard design. Different versions and/or special solutions are available on request.

Clean Room Light CP

This compact, integrated light fitting is best suited for flush installation into metal ceiling systems. Its construction makes it ideal for clean rooms with the highest hygienic requirements. It is particularly suitable for combining with clip-in cassette and exposed grid ceilings or for integration into ceiling panel cut-outs. The lights are characterised by their visually appealing and functional frames, which are held in place with a clamped clip fastening and enable fast, functional opening of the housing. An additional, closed-cell sealant is used between the frame and the housing to ensure necessary air-tightness.



1 = Housing for light fitting
2 = Frame
3 = 5-pin coupling connector

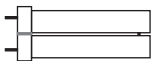

TC-L Lamp

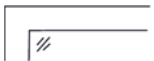

Edge design



Protection class



IP protection

Special features



Optionally as emergency lighting

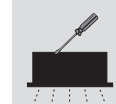

Operation from above optional

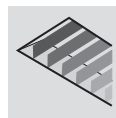

Also available with parabolic mirror



Technical specifications¹⁾

| | |
|--------------------------|--|
| Dimensions | 600 x 600 mm or 625 x 625 mm |
| Lighting height | 100 mm without plug (with plug + 15 mm) |
| Attachment to suspension | Riveting nut M5, on the side |
| Maintenance | From below (room side) |
| Material | Steel powder-coated |
| Colour | RAL 9016 |
| Voltage | 230 Volt / 50 Hz |
| Protection class | I |

| | |
|---------------------|---|
| Protective system | IP 65 (downwards) IP 50 (upwards) |
| Ballast | Electronic ballast |
| Reflectors | Built in as standard reflector type: wide beam |
| Lamp | 2 x TC-L 55 W |
| Lamp colour | Neutral white 840 |
| Finishing material | Structured ESG |
| Connection | 5-pin coupling connector |
| Connection location | Above the light box |

¹⁾ The specifications are valid for the standard design. Different versions and/or special solutions are available on request.

Clean Room Light RR

These compact, integrated lights are suitable for clean rooms with hygienic requirements and have been constructed for flush installation into clip-in cassette and exposed grid ceilings and also for integration into ceiling panel cutouts.

Stainless steel screws attach the cover to the frame allowing access for maintenance purposes.



- 1 = Housing for light fitting
- 2 = Housing frame
- 3 = Stainless steel screw
- 4 = Connection above strip terminal

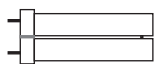

TC-L Lamp

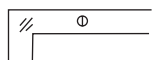

Edge design



Protection class



IP protection

Special features



Optionally as emergency lighting

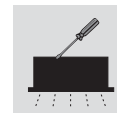

Operation from above optional

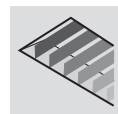

Also available with parabolic mirror



Technical specifications¹⁾

| | |
|--------------------------|------------------------------|
| Dimensions | 600 x 600 mm or 625 x 625 mm |
| Lighting height | 100 mm |
| Attachment to suspension | Deeply drawn thread M4, side |
| Maintenance | From below (room side) |
| Material | Steel powder-coated |
| Colour | RAL 9016 |
| Voltage | 230 Volt / 50 Hz |
| Protection class | I |

| | |
|---------------------|--|
| Protective system | IP 54 (downwards) IP 40 (upwards) |
| Ballast | Electronic ballast |
| Reflectors | Built in as standard reflector type: wide beam |
| Lamp | 2 x TC-L 55 W |
| Lamp colour | Neutral white 840 |
| Finishing material | Structured ESG |
| Connection | 3-pin strip terminal |
| Connection location | In the lights |

¹⁾ The specifications are valid for the standard design. Different versions and/or special solutions are available on request.

Clean Room Light KK

Ceiling lights made especially for clean rooms have to fulfil the highest performance standards. The construction of these compact, integrated lights means that they fulfil the hygiene standards for clean rooms when combined with clip-in cassette and exposed grid ceilings and when inserted into cut-outs in ceiling panels. Casement screws attach the cover to the frame, which can be accessed for maintenance purposes.



- 1 = Housing for light fitting
- 2 = Frame
- 3 = Casement screws
- 4 = 5-pin coupling connector

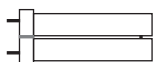

TC-L Lamp

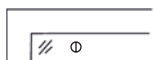

Edge design



Protection class



IP protection

Special features

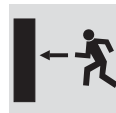

Optionally
as emergency
lighting

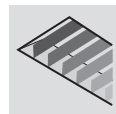

Also available with
parabolic mirror

Technical specifications¹⁾

| | |
|--------------------------|--|
| Dimensions | 600 x 600 mm or 625 x 625 mm |
| Lighting height | 115 mm without plug (with plug + 15 mm) |
| Attachment to suspension | Riveting nut M5, on the side |
| Maintenance | From below (room side) |
| Material | Steel powder-coated |
| Colour | RAL 9016 |
| Voltage | 230 Volt / 50 Hz |
| Protection class | I |

| | |
|---------------------|---|
| Protective system | IP 50 (downwards) IP 40 (upwards) |
| Ballast | Electronic ballast |
| Reflectors | Built in as standard reflector type: wide beam |
| Lamp | 2 x TC-L 55 W |
| Lamp colour | Neutral white 840 |
| Finishing material | Structured ESG |
| Connection | 5-pin coupling connector |
| Connection location | Above the light box |

¹⁾ The specifications are valid for the standard design. Different versions and/or special solutions are available on request.

Clean Room Light SH

These compact, integrated lights for metal ceilings more than serve their purpose: they fulfil all clean room requirements and can be integrated into clip-in cassette and exposed grid ceilings as well as ceiling panel cut-outs. Their frames offer visual and functional advantages and are clamp-clipped onto the light box, making them easily accessible. The built-in safety rope secures the frame and prevents the glass from falling out.

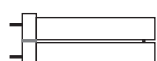

TC-L Lamp

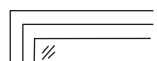

Edge design



Protection class



IP protection

Special features



Optionally
as emergency
lighting



Technical specifications¹⁾

| | |
|--------------------------|---------------------------------|
| Dimensions | 600 x 600 mm or 625 x 625 mm |
| Lighting height | 80 mm |
| Attachment to suspension | Deeply drawn thread M4, side |
| Maintenance | From below (room side) |
| Material | Steel powder-coated |
| Colour | RAL 9016 |
| Voltage | 230 Volt / 50 Hz |
| Protection class | I |

| | |
|---------------------|--------------------------------------|
| Protective system | IP 40 (downwards) IP 40 (upwards) |
| Ballast | Electronic ballast |
| Reflectors | Optionally available |
| Lamp | 2 x TC-L 55 W |
| Lamp colour | Neutral white 840 |
| Finishing material | Opal acrylic glass (milky) |
| Connection | 3-pin strip terminal |
| Connection location | In the lights |

1) The specifications are valid for the standard design. Different versions and/or special solutions are available on request.

Clean Room Light LF

The compactness of these integrated lights means that they can be installed flush into a variety of metal ceiling systems and are particularly good for strip metal ceilings as the length of the light fittings can be adjusted to fit. This lighting system meets all hygienic requirements prescribed by a clean room application. The lights are characterised by their visually appealing yet functional steel sheet housing. The cover is held in place with casement screws.



T5-FQ, T5-FH Lamp or
 T8-FQ Lamp



Edge design



Protection class



IP protection

Special features



Optionally
 as emergency
 lighting

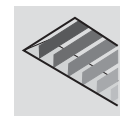

Also available
 with parabolic
 mirror

GMP
 suitable

Technical specifications¹⁾

| | |
|-----------------------------|-------------------------------------|
| Dimensions | Width of ceiling panels adjusted |
| Lighting height | 80 mm |
| Attachment to suspension | Front mounting bracket |
| Maintenance | From below (room side) |
| Material | Steel powder-coated |
| Colour | RAL 9016 |
| Voltage | 230 Volt / 50 Hz |
| Protection class | I |

| | |
|---------------------|---|
| Protective system | IP 50 (downwards) IP 40 (upwards) |
| Ballast | Electronic ballast |
| Reflectors | Built in as standard reflector type: wide beam |
| Lamp | 2 x T5TQ 54W |
| Lamp colour | Neutral white 840 |
| Finishing material | Structured ESG |
| Connection | 3-pin strip terminal |
| Connection location | In the lights |

¹⁾ The specifications are valid for the standard design. Different versions and/or special solutions are available on request.

Clean Room Light RS

These integrated ceiling lights fulfil all important properties of clean room lighting and are particularly suitable for use in sanitary areas where low lighting strengths are required. The housing is made of sheet steel with a white powder coating. As a finishing material a clear or opal glass is used. The cover, of clear or opaque glass, is held in place by a separate retaining ring which is attached to the light with three flat head screws. In particular, a closed-cell sealant ensures the correct clean room quality between the glass and the frame.

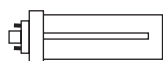

TC-DE Lamp



Edge design



Protection class



IP protection

Special features

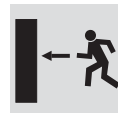

Optionally
as emergency
lighting



Technical specifications¹⁾

| | |
|--------------------------|------------------------|
| Dimensions | ø 220 mm |
| Lighting height | 125 mm |
| Attachment to suspension | With thrust springs |
| Maintenance | From below (room side) |
| Material | Steel powder-coated |
| Colour | RAL 9016 |
| Voltage | 230 Volt / 50 Hz |
| Protection class | I |

| | |
|---------------------|--------------------------------------|
| Protective system | IP 65 (downwards) IP 20 (upwards) |
| Ballast | Electronic ballast |
| Reflectors | Built in as standard |
| Lamp | 2 x TC-DE 26 W |
| Lamp colour | Neutral white 840 |
| Finishing material | Matt ESG |
| Connection | 3-pin strip terminal |
| Connection location | Above the light box |

1) The specifications are valid for the standard design. Different versions and/or special solutions are available on request.

Clean Room Light DL

These surface mounted triangular light fittings are ideal for installation at the junction between ceiling and wall. Comfortable lighting levels for work stations and all other areas has been taken into account; other integrated ceiling installations remain unaffected. For corner formation and for outsize lengths, visually appealing transition pieces can be installed to satisfy hygienic requirements.



1 = Housing for light fitting
2 = Connection above strip terminal



T5-FQ, T5-FH Lamp or
T8 Lamp



Protection class

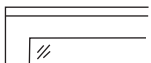

Edge design



IP protection

Special features



Optionally
as emergency
lighting



Optionally
as yellow
lighting

GMP
suitable

Technical specifications¹⁾

| | |
|--------------------------|---|
| Dimensions | 140 x 140 mm |
| Light length | T5 Lamp: 600 / 900 / 1,200 / 1,500 mm |
| Attachment to suspension | 2 attachment holes for each bracket |
| Maintenance | From below (room side) |
| Material | Steel powder-coated |
| Colour | RAL 9016 |
| Voltage | 230 Volt / 50 Hz |
| Protection class | I |
| Protective system | IP 54 (downwards) |

| | |
|---------------------|---|
| Ballast | Electronic ballast |
| Reflectors | Built in as standard |
| Lamp | T5 lamp: 1xT5 FQ 24 W length: 570 mm 1xT5 FQ 39 W length: 870 mm 1xT5 FQ 54 W length: 1,170 mm 1xT5 FQ 49 W length: 1,470 mm 1xT5 FQ 80 W length: 1,470 mm |
| Lamp colour | Neutral white 840 |
| Finishing material | Structured ESG |
| Connection | 3-pin strip terminal |
| Connection location | In the lights |

¹⁾ The specifications are valid for the standard design. Different versions and/or special solutions are available on request.

Clean Room Light TD

Either as individual lights or for light-band adjustment ²⁾ these lights are well suited for use in Laminar Flow Clean Rooms. Assembly is similar to that for surface-mounted lights in a ceiling grid. The lighting channel is made of sheet steel with a white powder coating. The light diffuser with interior light-reflecting longitudinal grooves is held in place with overlapping end caps made of profiled die cast aluminium. These end caps can be removed by being pulled downwards and are held in place either with springs or, as in the case of IP54, with screws in the lighting channel, enabling easy replacement of the lamp ²⁾ and avoiding the need for tools.

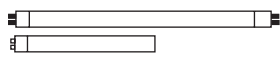
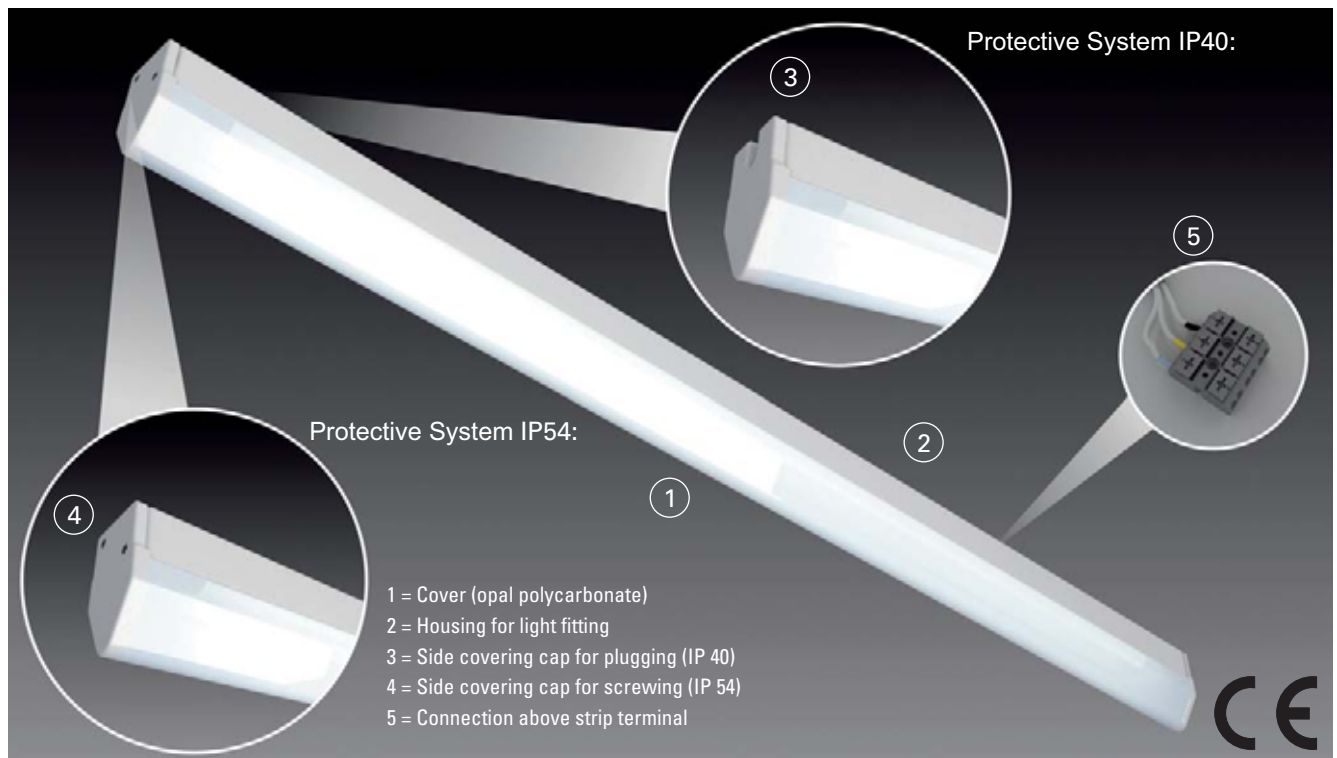

T5-FQ, T5-FH Lamp or
T8-FQ Lamp



Protection class



IP protection

Special features

G

Optionally
as yellow
lighting

GMP
suitable

Technical specifications¹⁾

| | |
|-------------------|--|
| Dimensions | Width: 50 mm, Height: 87 mm |
| Light length | T5 Lamp: 600 / 900 / 1,200 / 1,500 mm |
| | T8 Lamp: 650 / 1,250 / 1,550 mm |
| Attachment | Two holes on the back |
| Maintenance | From below (room side) |
| Material | Steel powder-coated |
| Colour | RAL 9016 |
| Voltage | 230 Volt / 50 Hz |
| Protection class | I |
| Protective system | IP 40 or IP 54 |
| Ballast | Electronic ballast |
| Reflectors | light diverting baffles in the finishing material (disc) |

| | |
|---------------------|--|
| Lamp | T5 lamp: |
| | 1xT5 FQ 24 W length: 570 mm |
| | 1xT5 FQ 39 W length: 870 mm |
| | 1xT5 FQ 54 W length: 1,170 mm |
| | 1xT5 FQ 49 W length: 1,470 mm |
| | 1xT5 FQ 80 W length: 1,470 mm |
| Lamp colour | T8 lamp: |
| | 1xT8 18 W length: 610 mm |
| | 1xT8 36 W length: 1,220 mm 1xT8 58 W length: 1,520 mm |
| Lamp colour | Neutral white 840 |
| Finishing material | Opal polycarbonate |
| Connection | 3-pin strip terminal |
| Connection location | In the lights |

1) The specifications are valid for the standard design. Different versions and/or special solutions are available on request.

2) Not with Protective System IP54.

Lindner Clean Air Technology

Pure quality.

Lindner ventilation components tick all the boxes when it comes to keeping your clean room free of particles and germs. We can equip all areas of clean room technology with the necessary ventilation components – from adjustable ceiling outlets for supply air and/or extracted air through to software-driven filter fan units and overflow grids for wall installations.



Silicon Sensor, Berlin

Areas of application

- Pharmacy and medical technology
- Electronic and semiconductor technology
- Microsystems & precision mechanical engineering and optics.
- OP technology
- Laboratories
- Food technology
- Computer rooms and control centres
- Surface treatment technology

FFU – Filter Fan Unit

The housing is made of warp resistant, self-supporting, dense sheet steel equipped with a sound insulating, odour-free, non-flammable coating with an abrasion-proof surface. The housing is connected to a motor, controller and plug plate by means of screws, making replacement of the components easy. The highly efficient particulate air filter is sealed tightly to the housing.



Components

Filter

- Filter assembly and disassembly plenum or clean room side
- Dry sealant or gel sealant
- Fan guard (clean room side)

Housing:

- Aluminium or steel (coated)

Ventilator

- One or three-phase AC motors
- EC motors with controllers and plug plates, communication via PC, BMS or decentralised operating units

Technical specifications

| | | |
|----------------------------|--|------------------------------|
| Air speed | 0,45 m/s | |
| Filter pressure difference | 120 Pa | |
| | Grid 1,200 x 600 mm | Grid 1,200 x 1,200 mm |
| Amount of air | 1,175 m ³ /h | 2,350 m ³ /h |
| Entire pressure difference | 330 Pa | 270 Pa |
| Volume L _{pA1.5} | 49 dB (A) | 50 dB (A) |
| Power input | 95 Watt | 155 Watt |
| Possible options | Cooler, heater, pre-filter, activated carbon filter, room diffuser etc | |
| Dimensions | Customer-specific dimensions are possible | |

Overflow Grids

Air inlet grills are used for exhaust air, supply air and overflow between two rooms and in doors. The size of the air inlet grill is adjusted to the required installation depth and is flush-mounted, with evenly distributed perforations. The shape of the frame allows the overflow grid to be self-supporting and independent of the wall construction.

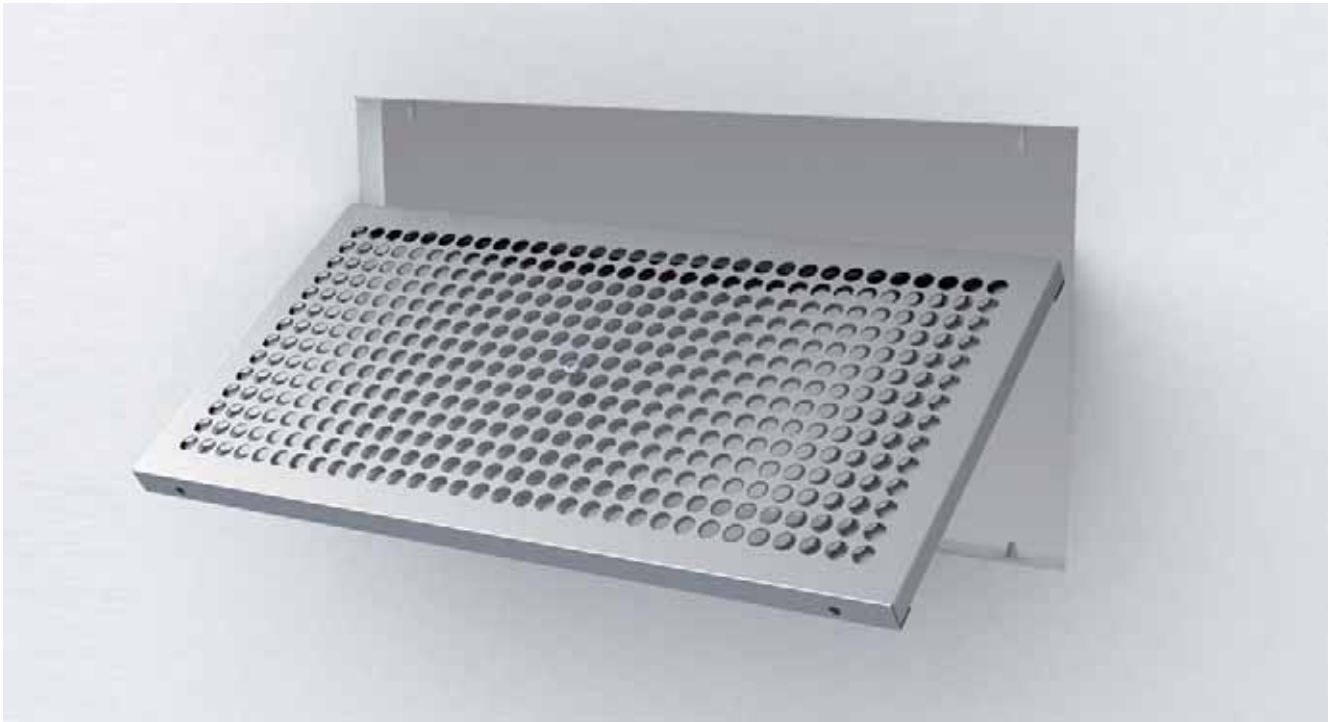

Technical specifications

| | „baffles“ | „antisept“ | „variovent 2“ | „variovent 3“ | „variovent 4“ |
|-----------------|---|------------|---|----------------------------|------------------------------|
| Cut-out width | variable | variable | 300 mm | 450 mm | 600 mm |
| Cut-out height | variable | variable | 200 mm | 300 mm | 450 mm |
| Air flow rate | variable | variable | 10 - 100 m ³ /h | 50 - 150 m ³ /h | 200 - 1300 m ³ /h |
| Open area | max. 70 % | max. 80 % | approx. 35 % | approx. 35 % | approx. 35 % |
| Adjustable area | no | no | yes | yes | yes |
| Materials | - Brushed or smooth stainless steel - Coated steel - Anodised aluminium | | - Brushed or smooth stainless steel - Coated stainless steel | | |

Special features



- Easy to clean
- Resistant to a variety of cleaning and disinfection agents on the VAH list (The Association for Applied Hygiene)

Product characteristics

- Flush installation
- Easy to maintain
- Can also be used in doors because of its minimal construction depth

Brush or smooth stainless steel“ schreiben sondern „Brushed or smooth stainless steel

Locks

For zone division in clean rooms, locks are essential. Locks are closed rooms that are found between two or more rooms, e.g. of different cleanliness classes. Rooms which are at different levels of clean room cleanliness are closed and locked from each other.

Lindner supplies different types of locks and control systems – made to fulfil your individual requirements.



Detail 1
Lock panel



Detail 2
Control box



Detail 3
Cable feed-through



Detail 4
Monitoring contact



Detail 5
Door latch +
additional catch lock



Detail 6
Closing plate +
door lock

Options

To meet the needs of the flow of people and materials, these high quality locks are divided into personnel, material and document locks and are explained below.

Personnel locks

Personnel locks are for use by people moving around the different clean room zones. When used they are designed and adjusted according to the number of people, their gender, the cleanliness class etc. They are to be used as clean room changing rooms and are built so that clothes and shoes can be left on the "unclean" side and the necessary clothes for the higher class of clean room can be put on. In personnel locks washing and disinfection agents are made available to ensure the most sterile and particle free conditions when entering the higher class of clean room. Contamination risks for the production areas are thus significantly reduced.

Material locks

Material locks are for taking materials and/or finished products, larger containers and packaging units in or out of the clean rooms. They are often equipped with two-wing doors so as to facilitate transport with a pallet truck. For larger production facilities and fork lift traffic rapid action doors suitable for clean rooms are used. Material locks are not touched by personnel, materials or products at the same time - depending on the directional flow of materials, they are received on one side and are removed on the other. When using these locks in clean rooms with a high cleanliness class, the goods are cleaned first before being accepted.

Material hatches

Material hatches are for taking materials and/or finished products, smaller containers and packaging units in or out of the clean rooms. They are usually built into the wall at chest height and are used either actively or passively depending on the clean room class. They can be built as GMP or built in a simple electronic design. Depending on the type of plant design the active modules can be attached to an existing ventilation system or can be equipped with their own ventilator for different types of flows. Different functions allow user-specific settings for the opening times of the door, the rinse time, the two-way locking of the doors as well as other user-defined properties.

Document locks

Document locks are a simple type of material locks and are primarily used to take documents in and out of the manufacturing area. They are built into the wall at chest height and are flush-mounted even when the walls are of different thicknesses. The glass panels make it easy to tell if a document or sample is to be taken out and also make the lock very easy to clean. A specially developed glass holder for documents can also be easily removed and cleaned.

Lock control

The lock controls prevent two or more types of lock from being operated at the same time, thus avoiding contamination of the various clean room areas. This can be achieved in various different ways. Many different designs of electrical locks can be used. Electrical door openers or magnetic clamps are placed on the doors which then either lock or unlock depending on the request or the authorisation level. Various types of controls are possible – these range from a simple electric switch with a relay through to a simple SPS control or complex software offering visual imagery of all rooms. For passive material locks or simple document locks mechanical locking devices are used instead of electrical locks. The same functionality is achieved with mechanical locking devices but they do not include such features as traffic lights (red/green), freely definable rinsing and locking times, monitoring of individual doors, locking multiple doors and rooms against each other, access control (e.g. with a card reader), unisex functions when both sexes are using one lock, extended communication (e.g. BUS connections) etc.

Surfaces

Of a special type.

Powder coating

Electrostatically charged polyester based powder particles are blown on to an earthed substrate and then linked by heating.



All colours from the RAL ¹⁾ and NCS ²⁾ ranges are available.

Coil-coating

A metallic substrate is given an organic coating in a continual process (band coating). The coating is then linked by heating.

Stainless steel

Brushed or smooth
V2A, V4A

Anodised aluminium

This is a process in which the surface of the aluminium is turned into aluminium oxide.

1) RAL Deutsches Institut für Gütesicherung und Kennzeichnung
(German Institute for Quality Assurance and Labelling)

2) NCS Natural Color System

AntiBac

For areas with high levels of hygiene requirements we recommend coating substructures and top layers with our antibacterial active powder varnish. The effect of AntiBac is tested to JIS Z 2801:2000.



Clinical centre Schwerin

Conductive coatings

These coatings are used to prevent electrostatic charges.

RAL colour tones are available.



Conductive coatings

Please note: The colours printed here will vary slightly from the original and are not colour consistent.

Look no longer for reasons not to.

Benefit now from the products of Lindner
Reinraumtechnik GmbH.

| Specification for tenders | Guidelines |
|--|--|
| <p>Request specifications for tenders by contacting us on: Tel. no. +49 (0)8723/20-36 71 Fax no. +49 (0)8723/20-23 55 or by e-mail directly to us at cleanrooms@Lindner-Group.com or visit us on the internet at www.Lindner-Group.com.</p> | <p>Assembly notes: All details correspond to the current state-of-the-art technology and the current DIN and EN norms as well as the other guidelines. Lindner Reinraumtechnik GmbH has a quality management system in accordance with DIN EN ISO 9001, DIN EN ISO 14001 and is certified by TÜV Management. As with all sophisticated planning, the best results and optimum function of our clean room systems are achieved when the greatest care is taken to install under suitable working conditions.</p> <p>Assembly conditions: The minimal requirements with regards to structure, logistics, coordination, building services, environment and temperature are to be observed when assembling the components. To enable installation suitable for clean room applications certain basic requirements must be ensured before assembly can begin. This is not part of the system manufacturer's or the installing company's range of services and has to be carried out by the client.</p> <p>Assembly of the clean room may only begin when the room has dried out and the facade is closed. Depending on the clean room class – which will be determined later – walls, ceiling and floors must be made free of dust using the most suitable coating and if necessary they must also be sealed. Any deviations from this are to be clearly defined.</p> <p>Service Technical details and documents (construction sheets with specification and assembly notes, test certificates, samples, etc) are available on request. We will be pleased to advise you on all systems with special requirements.</p> |

Standards and regulations

GMP guidelines

„Good Manufacturing Practice“

The GMP guidelines describe the quality assurance of the production processes and environment in which pharmaceuticals, active ingredients, medicinal products and also food and feed should be manufactured. As any deviation in this quality can have direct effects on the health of the consumer, these quality assurance guidelines are of the utmost importance for pharmaceutical manufacturers. They guarantee the product quality and ensure that the binding requirements of the health authorities are fulfilled.

VDI 2083

Clean air

These guidelines were introduced in the 70s and were mainly concerned with the cleanliness of the air, surfaces and services at work stations. Further parts of the guidelines go into detail about the equipment, personnel and operation of clean room facilities. Nowadays DIN EN ISO 14644 is usually used in place of VDI 2083.

DIN EN ISO 14644

Clean rooms and their corresponding areas

This international standard starts off by classifying the particle cleanliness of the air in clean rooms and then gives recommendations regarding planning, design, dimensions and operation of the plants. Parts 1 and 2 of ISO 14644 replaced the US Federal Standard 209E in 2001.

VDI 2167

Technical building services of hospitals

VDI 2167 applies to the technical planning of heating and clean air technology plants (air conditioning plants) in buildings and rooms where hospital work, treatments and operations are carried out on people. This can mean:

- hospitals in general
- day clinics
- doctors practices with operating rooms
- facilities for internal and external sterilisation services
- central sterilisation.

VDI 6022

Hygienic requirements for air conditioning plants in offices and meeting rooms

As for VDI 2167, VDI 6022 controls the planning, design, operation and maintenance requirements for air conditioning plants and their components. Particular attention is paid to the construction of the plant to prevent the uncontrollable accumulation of germs and bacteria and to enable easy cleaning.

Certification to ISO 9001 and ISO 14001

Our integrated management system ensures that our products and services are of high quality and constantly adjusts and further develops them to meet the needs of our customers. Consistent organisation structures guarantee coordinated processes from one source. Lindner Reinraumtechnik GmbH holds DIN EN ISO 9001 and DIN EN ISO 14001 certificates.



Cleanliness classes

GMP classes/US-FED-STD 209E (officially replaced by ISO in 2001)/DIN EN ISO 14644-1

| ISO | Class/Size | GMP | FED-STD 209D | ≥ 0.1 µm | | ≥ 0.2 µm | | ≥ 0.3 µm | | ≥ 0.5 µm | | ≥ 1 µm | | ≥ 5 µm | |
|---------|-------------|-----|-----------------|------------------|-------------------|------------------|-------------------|------------------|-------------------|------------------|-------------------|------------------|-------------------|------------------|-------------------|
| | | | | / m ³ | / ft ³ | / m ³ | / ft ³ | / m ³ | / ft ³ | / m ³ | / ft ³ | / m ³ | / ft ³ | / m ³ | / ft ³ |
| Class 1 | | | | 10 | | 2 | | - | | - | | - | | - | |
| Class 2 | | | | 100 | 3 | 24 | 1 | 10 | | - | | - | | - | |
| Class 3 | | | | 1,000 | 28 | 237 | 7 | 102 | 3 | 35 | 1 | 8 | | - | |
| | 1 | | | 1,240 | 35 | 265 | 7.5 | 106 | 3 | 35.3 | 1 | | | - | |
| Class 4 | | | | 10,000 | 283 | 2,370 | 67 | 1,020 | 29 | 352 | 10 | 83 | 2 | | |
| | 10 | | | 12,400 | 350 | 2,650 | 75 | 1,060 | 30 | 353 | 10 | | | - | |
| | A / B(r) | | | | | | | | | 3,500 | 99 | | | 1 | |
| Class 5 | | | | 100,000 | 2,832 | 23,700 | 671 | 10,200 | 289 | 3,520 | 100 | 832 | 24 | 29 | 1 |
| | 100 | | | - | - | 26,500 | 750 | 10,600 | 300 | 3,530 | 100 | | | - | |
| Class 6 | | | | 1,000,000 | 28,317 | 237,000 | 6,711 | 102,000 | 2,888 | 35,200 | 997 | 8,320 | 236 | 293 | 8 |
| | 1,000 | | | - | - | - | - | - | - | 35,300 | 1,000 | | | 247 | 7 |
| | B(o) / C(r) | | | | | | | | | 350,000 | 9,911 | | | 2,000 | 57 |
| Class 7 | | | | - | - | - | - | - | - | 352,000 | 9,968 | 83,200 | 2,356 | 2,930 | 83 |
| | 10,000 | | | - | - | - | - | - | - | 353,000 | 10,000 | | | 2,470 | 70 |
| | C(o) / D(r) | | | | | | | | | 3,500,000 | 99,110 | | | 20,000 | 566 |
| Class 8 | | | | - | - | - | - | - | - | 3,520,000 | 99,676 | 832,000 | 23,560 | 29,300 | 830 |
| | 100,000 | | | - | - | - | - | - | - | 3,530,000 | 100,000 | | | 24,700 | 700 |
| Class 9 | | | | - | - | - | - | - | - | 35,200,000 | 996,758 | 8,320,000 | 235,597 | 293,000 | 8,297 |

| Class | Particle | | | | | | Recommended limits of „colony-forming units“ (CFU) for microbiological contamination (a) | | | |
|-------|-------------|--------|------------------|----------------|------------------|--------|--|--------------------------------------|-----------------------------------|--|
| | at rest (r) | | in operation (o) | | in operation (o) | | Petri dishes (ø 90 mm) KBE / 4 hours (b) | Contact plates (ø 55 mm) KBE / plate | Glove print 5 fingers KBE / glove | |
| | ≥ 0,5 µm | ≥ 5 µm | ≥ 0,5 µm | ≥ 5 µm | ≥ 0,5 µm | ≥ 5 µm | | | | |
| A | 3,500 | 1 | 3,500 | 1 | 3,500 | 1 | < 1 | < 1 | < 1 | |
| B | 3,500 | 1 | 350,000 | 2,000 | 350,000 | 2,000 | 5 | 5 | 5 | |
| C | 350,000 | 2,000 | 3,500,000 | 20,000 | 3,500,000 | 20,000 | 50 | 25 | - | |
| D | 3,500,000 | 20,000 | Not determined | Not determined | Not determined | 200 | 100 | 50 | - | |

Note: The m³ and ft³ values for the US-FED-STD have been taken directly from the US-FED-STD-209E. The m³ values from the ISO classification were multiplied by a factor of 0.028317 and round up to the nearest whole number to get the ft³ values. Errors and omissions excepted.

a = this is an average value

b = individual Petri dishes can also be exposed for less than 4 hours

We can do it all for you.

Lindner Concepts:

- Insulation Engineering and Industrial Service
- Clean Rooms and Laboratories
- Airports and Airlines
- Railways and Tunnels
- Studios and Concert Halls
- Interior Fit-out and Furnishings
- Cruise Liner and Ship Fit-out
- Hotels and Resorts
- General Contracting

Lindner Products:

- Facades
- Ceiling Systems
- Lights and Lighting Systems
- Partition Systems
- Doors
- Floor Systems
- Heating and Cooling Technologies
- Dry Lining Systems

Lindner Service:

- Green Building
- Deconstruction and Gutting
- Clearance of Harmful Substances
- Research and Development
- Delivery
- General Planning
- Installation
- Maintenance
- Public-Private Partnership (PPP)

Lindner

Bahnhofstrasse 29
 94424 Arnstorf
 Germany
 Phone +49 (0)8723/20-3671
 Fax +49 (0)8723/20-2355
cleanrooms@Lindner-Group.com
www.Lindner-Group.com